

V-9815 WALL CORRIDOR ONE-WAY ANALOG SPEAKER

INTRODUCTION

The V-9815 Wall Corridor One-Way Analog Speaker may be used to provide paging from any Valcom talkback page controller. The V-9815 will cover an area up to 600 square feet and should be spaced 20 feet apart. Good quality paging will be heard up to 30 feet in front of the speaker.

Dimensions & Weight





- 6.75 "H x 15.75 "W x 6.75 "D
- (17.1 cm x 40.0 cm x 17.1 cm)
- Weight: 5.2 lbs (2.35 kg)

Environment

Suitable for indoor or outdoor installation



Precautionary Designations

	CAUTION RISK OF ELECTRIC SHOCK DO NOT OPEN	
CAUTION: To reduce the risk of electric shock, Do not remove cover. No user serviceable parts inside. Refer servicing to qualified service personnel.		
	This symbol indicates that dangerous voltage constituting a risk of electric shock is present within this unit.	
	This symbol indicates that there are important operating and maintenance instructions in the literature accompanying this unit.	

FCC Information

This equipment has been tested and found to comply with the limits for a Class A digital device, pursuant to Part 15 of the FCC Rules.

These limits are designed to provide reasonable protection against harmful interference when the equipment is operated in a commercial environment. This equipment generates, uses and can radiate radio frequency energy and if not installed and used in accordance with the instruction manual, may cause harmful interference to radio communications. Operation of this equipment in a residential area may cause harmful interference in which case the user will be required to correct the interference at his own expense.

INSTALLATION

Mounting

The V-9815 speaker enclosure is designed for double gang FD electrical box.

Remove the speaker assembly from the packing container. Using a Phillips screwdriver, remove the screws securing the Front Grille to the enclosure. Next, remove 4 screws securing the Speaker Baffle to the Mounting Plate. Pre-drilled 13/64" mounting holes in the Mounting Plate are designed to fit a single gang, double gang or octagon outlet box. If not attaching to an outlet box, use the Mounting Plate as a template to mark the location of mounting holes. Prepare mounting hole locations to securely attach the Mounting Plate. Feed the signal and power wires through the opening in the Mounting Plate and securely attach the Mounting Plate to the wall. Guide the wires through the back of the Speaker Baffle and attach to the terminal strip as shown in Figure 3. As shown in Figure 1, connect the audio wires to the TIP and RING terminals on the speaker. Connect the power wires to the -24V and GND power terminals. Insert stripped wire into the appropriate terminal and clamp the wire by tightening the screw on the terminal.

After making signal connections, align the Speaker Baffle with the Mounting Plate and reinstall 4 screws to securely attach the Baffle to the Mounting Plate. If necessary, speaker volume may be adjusted using volume control (on the circuit board).

Reinstall Front Grille over Speaker Baffle and secure with 8 screws.

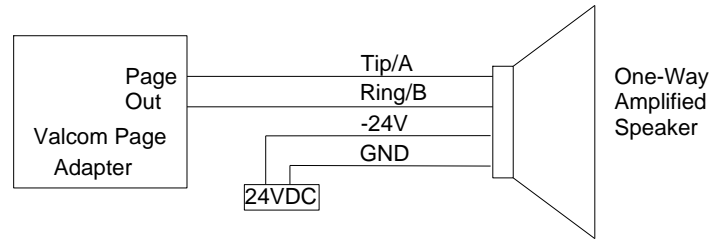

FIGURE 1

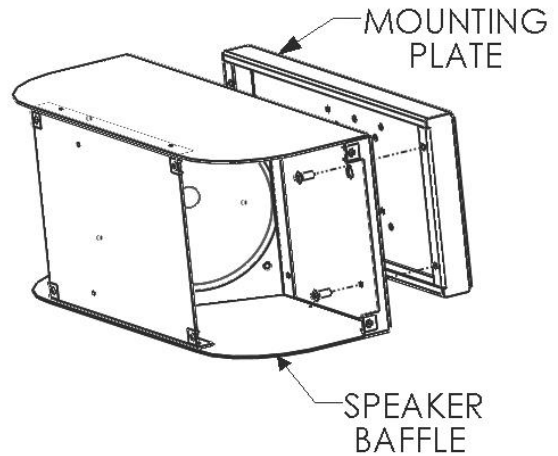

FIGURE 2

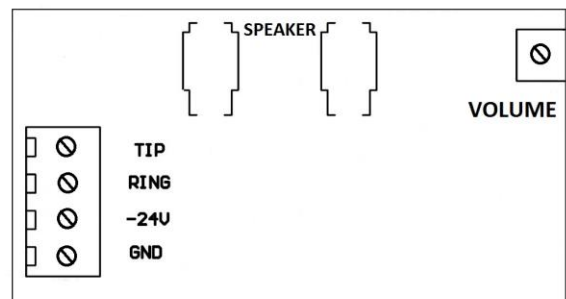

FIGURE 3

TROUBLESHOOTING CHART

SYMPTOM	ACTION
No audio from speaker	<ol style="list-style-type: none"> 1. Verify volume control is turned up (clockwise). 2. Using a lineman's test set, check for proper audio level on Tip/A and Ring/B leads and if necessary at the source.
Low volume from speaker	<ol style="list-style-type: none"> 1. Verify volume control is turned up. 2. Check voltage at the speaker when in use (-18 to -24VDC required). 3. Using a lineman's test set, check for proper audio level on Tip/A and Ring/B leads. It is possible some low level audio will be heard with only one side of Tip/A and Ring/B connected.
Loud squeal (feedback)	<ol style="list-style-type: none"> 1. Decrease volume of speaker (counterclockwise). 2. Increase the distance between telephone and speaker. 3. Install confidencer on the telephone in severe problem areas.

TECHNICAL ASSISTANCE

Assistance is available from the factory. Call (540) 563-2000 and press 1 for Technical Support or visit our website at <http://www.valcom.com>.

Valcom equipment is not field repairable. Valcom, Inc. maintains service facilities in Roanoke, VA. Should repairs be necessary,

attach a tag to the unit clearly stating company name, address, phone number, contact person and the nature of the problem. Send the unit to:

Valcom, Inc.
Repair and Return Dept.
5614 Hollins Road
Roanoke, VA 24019-5056

VALCOM LIMITED WARRANTY

Valcom, Inc. warrants its products only to the original purchaser, for its own use, to be free from defects in materials and workmanship under conditions of normal use and service for a period of one year from the date of shipment. This Limited Warranty obligation shall be limited to the replacement, repair or refund of any such defective device within the warranty period, provided that:

1. inspection by Valcom, Inc. indicates the validity of the claim;
2. the defect is not the result of damage, misuse or negligence after the original shipment;
3. the product has not been altered in any way or repaired by others and that factory sealed units are unopened (a service charge plus parts and labor will be applied to units defaced or physically damaged);
4. freight charges for the return of products to Valcom are prepaid;
5. all units 'out of warranty' are subject to a service charge. The service charge will cover minor repairs (major repairs will be subject to additional charges for parts and labor).

This Limited Warranty is in lieu of and excludes all other warranties, expressed or implied and in no event shall Valcom, Inc. be liable for any anticipated profits, consequential damages, loss of time or other losses incurred by the buyer in connection with the purchase, operation, maintenance, installation, removal or use of the product. The maximum liability of Valcom under this warranty is limited to the purchase price of the specific Product covered by the warranty.

Disclaimer. Except for the Limited Warranty provided herein, the product is provided "as-is" without any warranty of any kind whatsoever including, without limitation, any **WARRANTY OF MERCHANTABILITY, FITNESS FOR A PARTICULAR PURPOSE OR NON-INFRINGEMENT.**

This warranty specifically excludes damage incurred in shipment. In the event a product is received in damaged condition, the carrier should be notified immediately. Claims for such damage should be filed with the carrier involved in accordance with the F.O.B. point.

Headquarters:
 Valcom, Inc.
 5614 Hollins Road Roanoke, VA 24019-5056
 Phone: (540) 563-2000 FAX: (540) 362-9800