

VL550F, VL550M-F

IP MESSAGE DISPLAY with SPEAKER / TEXT / FLASHER

INTRODUCTION

The VL550F IP Message Display with Speaker/Text/Flasher provides highly visible message output and voice paging and/or intercom over an Ethernet network. Messages are created and delivered from the Valcom Application server (VE6025). Audio messages can be created from any Valcom IP Paging source.



SPECIFICATIONS

Features

- RJ-45 network connection
- Easy to read, high visibility
- Font and color options
- Power over Ethernet (PoE+) 802.3at compatible
- High efficiency speaker
- Relay connection for optional equipment
- Bright Flasher activates on priority page
- Speaker output and LED display can be activated together or separately
- Display can operate as a clock, or provide other message during idle periods
- Available in Black (VL550F) or Metallic (VL550M-F).

DIMENSIONS/WEIGHT

- 41.75" L x 5.88" H x 3.00" D (Top),
2.50" D (Bottom)
(106.0 cm W x 14.9 cm H x 7.6 cm D (top) x
6.4 cm D (Bottom))
- Weight: 9.2 lbs (4.2 kg)

Nominal Power Requirements

- 802.3at (PoE Plus) Class 4

Environment

Temperature: 0 to +40° C
 Humidity: 0 to 85% non-precipitating
 Indoor installation only

These products are intended for use with a UL Listed power source marked "Class 2" or "LPS" rated 24VDC, or 48VDC (PoE). PoE and all interconnected ITE are intended for intra-building.

Precautionary Designations

- **WARNING-To Reduce The Risk Of Fire Or Electric Shock. Do Not Expose This Apparatus To Rain Or Moisture.**
- **AVERTISSEMENT - Afin de réduire les risques d'incendie ou de décharge électrique, évitez d'exposer le système à la pluie ou à l'humidité.**
- **Apparatus shall not be exposed to dripping or splashing and no objects filled with liquids, such as vases, shall be placed on the apparatus.**
- **L'appareil ne doit pas être exposé à des égouttements et éclaboussures et aucun Objet Rempli de liquide, comme vase, ne doit être placé sur l'appareil.**





FCC Information

This equipment has been tested and found to comply with the limits for a Class A digital device, pursuant to Part 15 of the FCC Rules. These limits are designed to provide reasonable protection against harmful interference when the equipment is operated in a commercial environment. This equipment generates, uses and can radiate radio frequency energy and if not installed and used in accordance with the instruction manual, may cause harmful interference to radio communications. Operation of this equipment in a residential area may cause harmful interference in which case the user will be required to correct the interference at one's own expense.

IMPORTANT SAFETY INFORMATION

CONSIGNES DE SÉCURITÉ IMPORTANTES

1. Read these instructions.
Lisez ces instructions.
2. Keep these instructions.
Conservez ces instructions.
3. Heed all warnings.
Respectez tous les avertissements.
4. Follow all instructions.
Suivez toutes les instructions.
5. Do not use this apparatus near water.
Ne pas utiliser cet appareil près de l'eau.
6. Clean only with dry cloth.
Nettoyer avec un chiffon sec.
7. Do not block any ventilation openings. Install in accordance with the manufacturer's instructions.
Ne pas bloquer les ouvertures de ventilation. Installer conformément aux instructions du fabricant.
8. Do not install near any heat sources such as radiators, heat registers, stoves or other apparatus (including amplifiers) that produce heat.
Ne pas installer à proximité de sources de chaleur telles que radiateurs, registres de chaleur, poêles ou autres appareils (y compris les amplificateurs) produisant de la chaleur.
9. Do not defeat the safety purpose of the polarized or grounding-type plug. A polarized plug has two blades with one wider than the other. A grounding type plug has two blades and a third grounding prong. The wide blade and the third prong are provided for your safety. If the provided plug does not fit into your outlet consult an electrician for replacement of the obsolete outlet.
Ne pas contourner le dispositif de sécurité de la fiche polarisée ou de mise à la terre. Une fiche polarisée possède deux lames dont une plus large que l'autre. Une fiche de terre à deux lames et une troisième broche de mise à la terre. La lame large et la troisième broche sont fournies pour votre sécurité. Si la fiche fournie ne rentre pas dans votre prise, veuillez consulter un électricien pour le remplacement de la prise obsolète.
10. Protect the power cord from being walked on or pinched particularly at plugs, convenience receptacles and the point where they exit from the apparatus.
11. Only use attachments/accessories specified by the manufacturer.
N'utilisez que des fixations / accessoires spécifiés par le fabricant.
12. Use only with the cart, stand, tripod, bracket or table specified by the manufacturer or sold with the apparatus. When a cart is used, use caution when moving the cart/apparatus combination to avoid injury from tip-over.

Utilisez uniquement avec le chariot, stand, trépied, support ou table spécifié par le fabricant ou vendu avec l'appareil. Quand un chariot est utilisé, Soyez prudent lorsque vous déplacez l'ensemble chariot / appareil pour éviter des blessures dues au renversement.
13. Unplug this apparatus during lightning storms or when unused for a long period of time.
Débranchez cet appareil pendant les orages ou lorsqu'il n'est pas utilisé pendant une longue période de temps.
14. Refer all servicing to qualified service personnel. Servicing is required when the apparatus has been damaged in any way. Such as when the power supply cord or plug is damaged, liquid has been spilled, objects have fallen into the apparatus or the apparatus has been exposed to rain or moisture and does not operate normally or has been dropped.
Confiez toute réparation à un personnel qualifié. Une réparation est nécessaire lorsque l'appareil a été endommagé de quelque façon. Par exemple lorsque le cordon d'alimentation ou la fiche est endommagé, du liquide a été renversé, si des objets sont tombés dans l'appareil ou que l'appareil a été exposé à la pluie ou à l'humidité et ne fonctionne pas normalement ou s'il est tombé.

	CAUTION RISK OF ELECTRIC SHOCK DO NOT OPEN	
CAUTION: To reduce the risk of electric shock, Do not remove cover. No user serviceable parts inside. Refer servicing to qualified service personnel.		
	This symbol indicates that dangerous voltage constituting a risk of electric shock is present within this unit.	
	This symbol indicates that there are important operating and maintenance instructions in the literature accompanying this unit.	

INSTALLATION

Mounting

The VL550F message display should be mounted with appropriate hardware (not included). We recommend the mounting base to be mounted into wall studs. (See Figure 2)

Network Connection / Power

The RJ45 Ethernet port is accessible through the cutout in the display base. Connect a standard patch cable to the VL550F from an Ethernet switch supporting the Power over Ethernet specification 802.3at (PoE+). If a PoE+ switch is not available, a mid-span injector may be used to supply power to the display.

Call Switch Connection

The VL550 provides two Call Switch inputs via screw terminal connections labeled Switch 1 and Switch 2 (See Figure 1). Either Switch connection can be used for Call Switches, however if the Countdown function is required, use the VE2979 Count Up/Down Timer Control on Switch 2 only.

Relay Connection

One relay output is provided through three screw terminals, labeled Normally Open (NO) and Normally Closed (NC). The center screw terminal is common to both NO and NC. The relay contacts are rated 1 amp @ 24 Vdc.

Line Out Connection

The Line Out connection provides line level output sufficient to drive up to 40 Valcom self-amplified speakers.

Status / Demo / Reset

A multifunction button is provided to display information, and/or reset the VL550F configuration. The button is located behind a pinhole in the case of the VL550F and can be depressed using a small diameter object, such as a toothpick. The button provides different results depending on how long the button remains depressed.

Status Mode

Press the button for approximately 1 second and release and the Status display will show the current IP Address, Power Source status and the last four digits of the MAC address.

Demo Mode

While the Status display is active, pressing the button again will enable Demo Mode. In this mode, the VL550F will display a scrolling sample message and the flashers will flash. Demo Mode will display for about 30 seconds then the VL550F returns to normal operation.

Reset Modes

Pressing the button continuously for greater than 10 seconds, but less than 20 seconds, will

perform a soft reset on the VL550F. The IP address will be reset to the factory default setting. Other configuration items will not be affected.

Pressing the button continuously for greater than 20 seconds will perform a hard reset on the VL550F. All of the configuration items (including the password) will be reset to factory default settings.

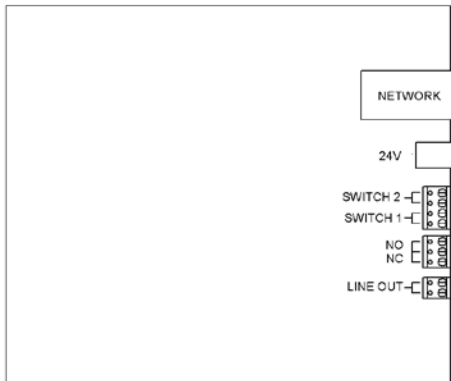

Figure 1. Network Connections

Setup

Information specific to your application will need to be programmed into the VL550F using a computer. The PC used for the programming should be connected to the same subnet as the display. Setup will be done using the IP Solutions Setup Tool. Download the latest version of the free IP Solution Setup Tool from Valcom website at www.valcom.com/vipsetuptool.

The VL550F audio output can be generated from any Valcom IP Paging source, such as the VIP-201A SIP Paging Server or a VIP-811A Network Station Port. Message displays are programmed and delivered by a Valcom Engineered Solutions VE6025 Application Server. Contact Valcom Engineered Solutions for details on the VE6025 Application Server.

TECHNICAL ASSISTANCE

Assistance is available from the factory when problems are encountered. Call (540) 563-2000 and press 1 for Technical Support or visit our website at <http://www.valcom.com>.

Valcom, Inc. equipment is not field repairable. Valcom maintains service facilities in Roanoke, VA. Should repairs be necessary, attach a tag to the unit clearly stating company name, address, phone number, contact person, and the nature of the problem. Send the unit to:

Valcom, Inc.
Repair and Return Dept.
5614 Hollins Road
Roanoke, VA 24019-5056

WARRANTY

Warranty information may be found on our website at www.valcom.com/warranty.

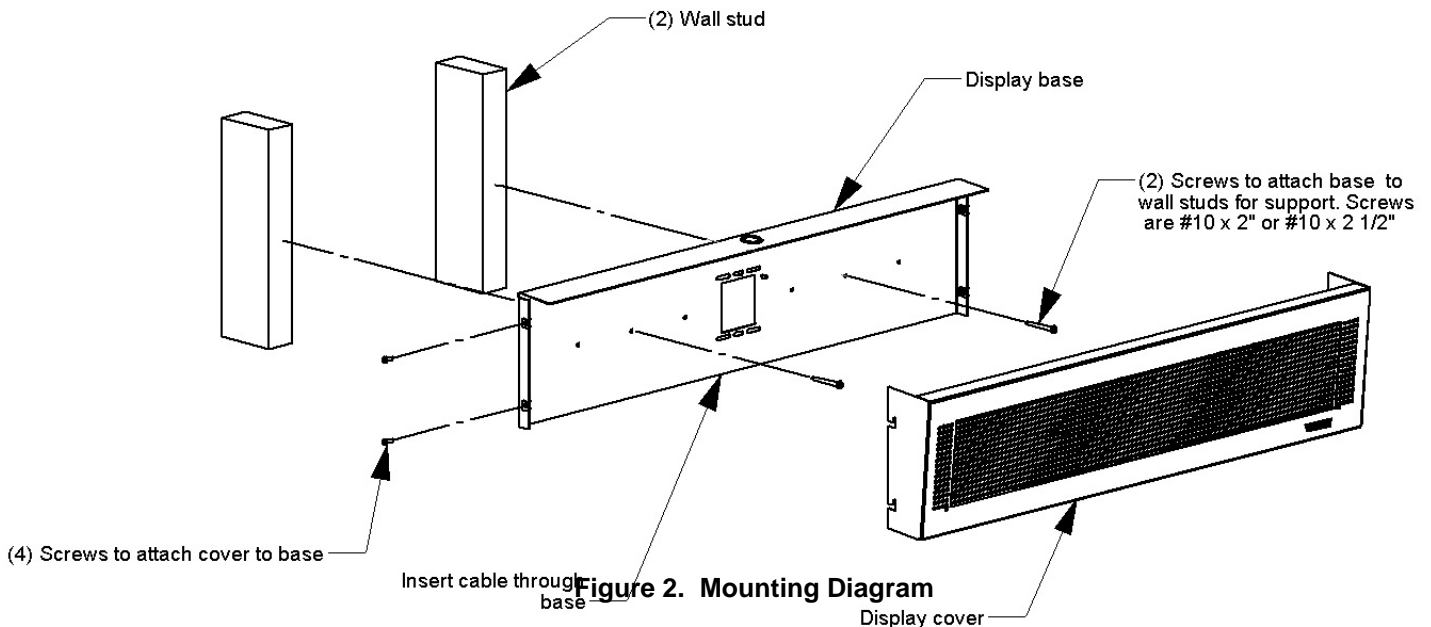

Figure 2. Mounting Diagram