



WE PROVIDE SOLUTIONS.

Valcom's long tradition of communication leadership and innovation addresses our customers' most complex communication concerns. Our products are developed to fit each unique situation.



**IP Speakers
improve upon
the benefits
offered by
self-amplified
speakers**

Benefits of Valcom IP and self-amplified speakers

- System power increases with every addition resulting in unlimited speaker expansion
- Full range volume control per speaker allows individual speaker volume adjustment
- Dedicated speaker amplifiers allow for multiple simultaneous announcements
- Installation by a low voltage contractor does not require expensive conduit in most municipalities
- One-way announcements and two-way talkback intercom easily coexist
- Dedicated speaker amplifiers provide the ultimate redundancy and system efficiency
- If an amplifier fails in an old fashioned 25/70/100 V system, many or all speakers stop working, if an amplifier fails in a Valcom system, one speaker stops working

IP speakers provide these additional benefits as well

- Remote software/browser-based management with inherent supervision
- Software based remote volume adjustment
- Digitized audio transmission prevents the possibility of crosstalk or signal loss
- PoE design eliminates the need for separate power supplies
- Unlimited access paths allow for multiple simultaneous announcements
- VoIP systems deploy quickly and easily span buildings, campuses, cities, states and countries
- Many methods of access, FXO, telephone, Session Initiation Protocol (SIP), microphone, browser
- Extremely low bandwidth per announcement, even when broadcasting to thousands of speakers
- Make announcements through one, or any combination of speakers and horns
- Seamless integration with most existing/new analog speakers and horns
- VoIP paging is a perfect choice for enterprises focusing on the long-term cost savings and many other advantages of convergence
- VoIP endpoints are easily configured and managed by network administrators or A/V technicians
- EMI immune inter-building fiber infrastructure is commonly available for IP data networks
- The number of technicians skilled in, and available to support and maintain VoIP systems is rapidly expanding, while the number of technicians familiar with analog technology is diminishing

Valcom is a leading manufacturer

of analog and IP communications equipment.

In addition to Valcom's robust communication protocol, many of our IP products are compatible with InformaCast®, Syn-Apps® and/or Session Initiation Protocol (SIP).



We offer many choices to fit your application. It's easy to let Valcom design a system to your requirements!

Send an e-mail to quotes@valcom.com with:

- **The intent of the system**
- **Your preferred technology, IP, analog, hybrid**
- **The number and types of for each area**
 - Speakers
 - Horns
 - Clocks
 - LED signs
- **How you plan to access the system**
 - SIP
 - Microphone
 - FXO port
- **Desired features**
 - Bell schedules
 - Prerecorded emergency messages
 - Alerts to computer screens
 - Feedback elimination
 - Panic buttons
 - Graphical user interface

Need help? Contact global@valcom.com



Speakers & Horns

Page Number

Ceiling Speakers	4-6
Signature Series High-Fidelity Speakers	7
Wall Speakers	8-10
Vandal-Resistant Speakers	11
Horns	12-13

Paging

SIP Paging	14-17
Interactive Console	18
SIP Gateways	19
IP6K HeadEnd Communication Package	20-21
Telephone Paging Server	22
Universal Paging Adapter	23-24
Analog Paging	25-26
Power Supplies	27
Advanced Communication Systems	28-29
Intercom/Door Entry	30-31

Accessories

Call Buttons	32
Spot SoundMasking, Sounds	33
Microphones	34
Paging Expansion	35
Managing Sound	36
Feedback, Message-On-Hold	37
Tones, Strobes	38
LED Message-Sign-Speakers	39
SIP Emergency Call Stations	40-41

Clock Systems

Clocks IP PoE Clocks, Wireless, Wired	42-43
Clock Controls, Drivers & Accessories	44
IP Clock/Speaker Combos	45
IP Clock Speaker Kits	46
Clock/Speaker Assemblies	47



B

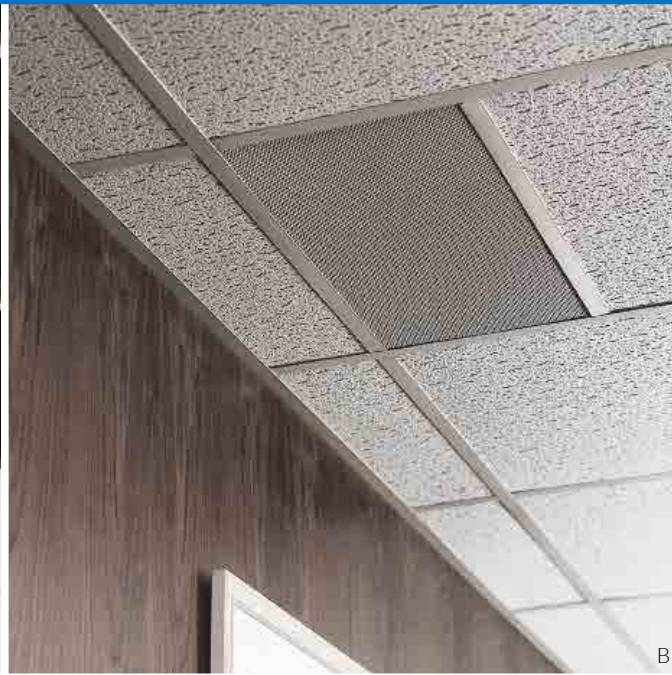

B

Fastest and Easiest
Speaker to Install!

Lay-In Ceiling Speakers

Easy Lay-In installation replaces a 2' x 2' tile

Save time, effort and money — Get on and off the job quickly

No cutting tiles, no broken tiles, no mess

Lightweight — weighs slightly more than a 2' x 2' ceiling tile

Includes integral backbox that meets/exceeds



Back of A

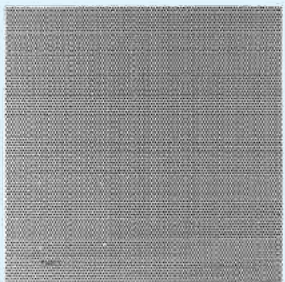

A

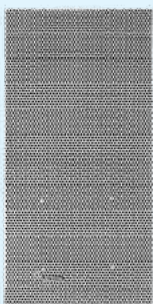

B

A 2' x 2'

Colors: White (paintable), Custom Colors -CC

IP One-Way	5.50lbs (2.49kg)	VIP-402A
IP One-Way InformaCast®	5.50lbs (2.49kg)	VIP-402A-IC
IP One-Way Syn-Apps®	5.50lbs (2.49kg)	VIP-402A-SA
IP One-Way, European Ver. InformaCast®	5.50lbs (2.49kg)	VIP-402A-EC-IC
IP Talkback	5.50lbs (2.49kg)	VIP-422A
IP Talkback, InformaCast®	5.50lbs (2.49kg)	VIP-422A-IC
IP Talkback, Syn-Apps®	5.50lbs (2.49kg)	VIP-422A-SA

One-Way (2 Pack)	13.50lbs (6.08kg)	V-9022A-2	1
One-Way, European Version	5.80lbs (2.63kg)	V-9022-EC	1
One-Way, Dual-Input	5.80lbs (2.63kg)	V-9028	1
Talkback	5.50lbs (2.49kg)	V-9062	0

U.S. Version: 23.75in L x 23.75in W x 3.75in D (60.33cm x 60.33cm x 9.53cm)

European Version: 600mm x 600mm

B 1' x 2'

Colors: White (Paintable), Custom Colors -CC

One-Way	11.75in L x 23.75in W x 3.75in D (29.85cm x 60.33cm x 9.53cm)	4.70lbs (2.12kg)	V-9021	1
---------	---	------------------	--------	---

Accessory:

Use to install in a 2' x 4' ceiling tile

Trim T-Bar (10 Pack)	24.50in L x 1.25in W x 1.00in D (62.23cm x 2.54cm x 3.18cm)	3.50lbs (1.58kg)	V-TBAR
----------------------	---	------------------	--------

Ceiling Speakers

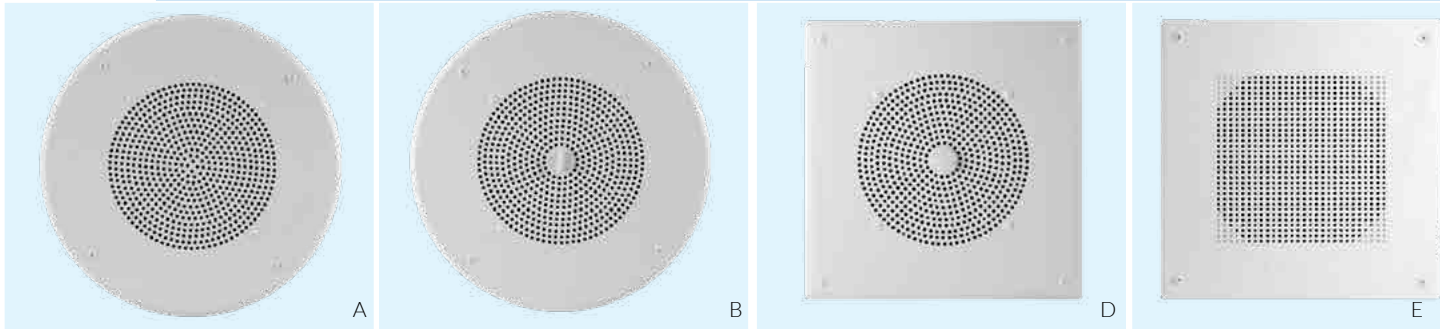

Round Ceiling Speakers

- Exceptional voice and music reproduction
 - Contains its own built-in amplifier
 - White epoxy finish
- Colors: white (paintable), Custom Colors -CC

A 8-Inch Round

IP One-Way	VIP-120A
IP One-Way InformaCast®	VIP-120A-IC
IP One-Way Syn-Apps®	VIP-120A-SA
IP Talkback	VIP-160A
IP Talkback, InformaCast®	VIP-160A-IC
IP Talkback, Syn-Apps®	VIP-160A-SA
13.00in Dia x 3.80in D (33.02cm x 9.70cm)	2.50lbs (1.13kg)

B One-Way features: "Pop-On/Pop-Off" volume control knob

One-Way	V-1020C ①
13.00in Dia x 3.80in D (33.02cm x 9.70cm)	2.50lbs (1.13kg)
One-Way, Dual-Input	V-1220 ①
13.00in Dia x 3.00in D (33.02cm x 7.62cm)	2.30lbs (1.04kg)
Talkback	V-1060A ②
13.00in Dia x 2.50in D (33.02cm x 6.35cm)	2.50lbs (1.13kg)

C 4-Inch Round

One-Way	V-1010C ①
7.65in Dia x 2.90in D	
(19.43cm x 7.37cm)	
1.70lbs (0.77kg)	

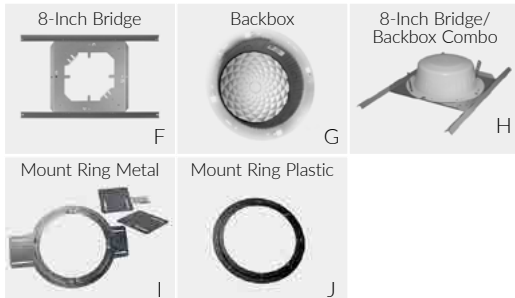
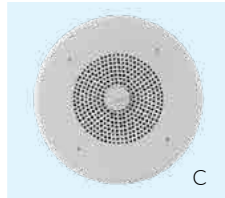

Accessories: Mounting Hardware M = Metal, P = Plastic

8-Inch Round Ceiling Speaker

F Speaker Bridge (5 Pack)	V-9914M-5
G Backbox (5 Pack)	V-9915M-5
H Bridge/Backbox Combo	V-9916M
I Pre-Construction Mounting Ring (10 Pack)	V-9912M-10
J Post-Construction Mounting Ring (12 Pack)	V-9912P-12

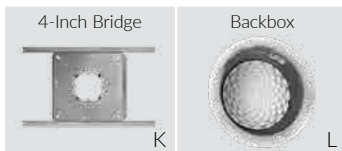

4-Inch Round Ceiling Speaker

K Speaker Bridge (5 Pack)	V-9904M-5
L Backbox (5 Pack)	V-9915M-5

Use V-9904M-5 Bridge & V-9915M-5 Backbox together for a combo.

Square Ceiling Speakers

- Exceptional voice and music reproduction
- Wide sound dispersion
- Electrically, acoustically matched components
- Sturdy steel grille

Colors: white (paintable), Custom Colors -CC

D Square Ceiling – Round Hole Pattern

One-Way features: "Pop-On/Pop-Off" volume control knob

One-Way	V-1920C ①
Talkback 4 Volume Tap Settings	V-CTSQPK ②
11.50in H x 11.50in W x 3.00in D (29.21cm x 29.21cm x 7.62cm)	2.60lbs (1.18kg)

E Square Ceiling – Square Hole Pattern

IP One-Way or Talkback Programmable	VIP-428A
IP One-Way, InformaCast®	VIP-418A-IC
IP Talkback, InformaCast®	VIP-428A-IC
IP Talkback, Syn-Apps®	VIP-428A-SA
One-Way	V-1921 ①
Talkback	V-1961 ②
11.50in H x 11.50in W x 4.00in D (29.21cm x 29.21cm x 10.16cm)	2.60lbs (1.81kg)



Accessories: Optional Backboxes for 8-Inch Round or Square Speakers

M Angled Mount	VB-A13
11.54in H x 11.63in W x 4.60in D[t] x 3.15in D[b]	
N Recessed Mount	VB-R12
10.75in H x 10.75in W x 3.94in D	
O Surface Mount	VB-S11
11.63in H x 11.63in W x 3.94in D	



A

Fast Installation Quick to Relocate!

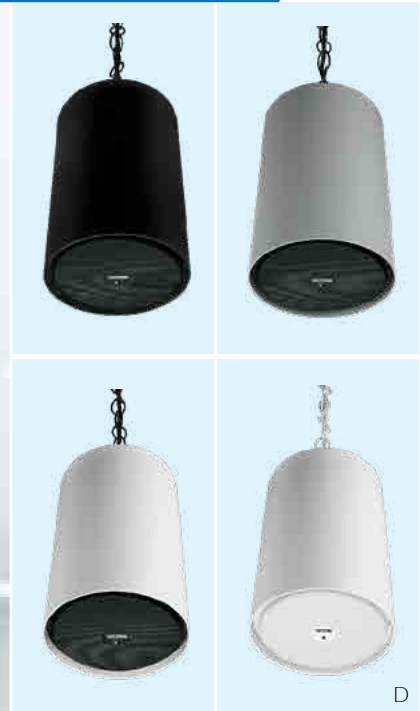

D



A

A P-Tec™ Ceiling Speaker

Easy push/lock speaker installs in tile ceilings

- Great for open offices where speaker relocation is made easier
- Side dispersion angle
- Lightweight, easy to mount and move

Color: White

One-Way **V-1001** -1

8.00in Dia x 2.50in H (20.32cm x 6.35cm) 0.75lbs (.34kg)



B

B Clean Room Speaker

Designed for applications where concentration of airborne particles is controlled. For pharmaceutical, medical and other critical manufacturing environments

- Large rubber o-ring to seal the grille to the ceiling
- Rubber washers for all mounting hardware
- Polycarbonate dust shield between speaker and grille

Color: White

IP One-Way or Talkback Programmable **VIP-140A**

One-Way **V-1040** -1

13.00in Dia x 3.00in D (33.02cm x 7.62cm) 2.5lbs (1.13kg)



C

C Surface Mount Ceiling Vandal-Resistant Speaker

Ideal for concrete ceilings and harsh areas: correctional institutions, outside entrances, industrial

- Tapered exterior, heavy-gauge steel construction
 - Steel-mesh security screen prevents objects from penetrating speaker
 - Tamper-resistant screws resist removal
 - White epoxy finish, available in Custom Colors
- Colors: White (Paintable), Custom Colors -CC

One-Way **V-9010-W** -1

8.50in Dia x 5.10in D (21.59cm x 12.95cm) 4.80lbs (2.18kg)

D Pendant Speakers

Great for high ceilings

Ideal for: retail, restaurant, office, hallway, and covered patios

- High-efficiency speaker
- Metal, weather-resistant enclosure
- Simply hang from included six foot chain

Housing Colors: Black -BK, Gray -GY, White -W, Custom Colors -CC

IP One-Way or Talkback Programmable **VIP-415**

IP One-Way, InformaCast® ... **VIP-415-IC**

Black Grill

One-Way **V-1015B** -6

White with White Grill

One-Way **V-1015B-WW** -6

5.80in Dia x 8.80in H (14.73cm x 22.35cm) 3.20lbs (1.45kg)

Accessory:

Additional Six Foot Chain **V-1093BK**

A Signature Series™ Lay-In Ceiling Speaker™

Easy Lay-In Installation Replaces a 2' x 2' Tile

- Save time, effort and money
 - Get on and off the job quickly
- No cutting tiles, no broken tiles, no mess
- Lightweight - weighs slightly more than a 2' x 2' ceiling tile
- Includes integral backbox that meets/exceeds ASTM E84 Flame & Smoke Test
- White epoxy finish

Colors: White (Paintable), Custom Colors -CC

One-Way **V-1422 -4**
 23.75in L x 23.75in W x 3.75in D (60.33cm x 60.33cm x 9.53cm)
 5.50lbs (2.49kg)



Accessory:

Use to install in a 2' x 4' ceiling tile

Trim T-Bar (10 Pack) **V-TBAR**
 24.50in L x 1.25in W x 1.00in D (62.23cm x 2.54cm x 3.18cm)
 3.50lbs (1.58kg)

C Signature Series™ Monitor

- Easy install
- Shelf mount or wall mount with optional mounting bracket

Colors: Black -BK, White -W, Custom Colors -CC

One-Way **V-1440 -4**
 7.00in H x 10.3in W x 4.70in D
 (17.78cm x 26.16cm x 11.94cm) 5.20lbs (2.36kg)

Accessories:

Optional Wall Mounting Bracket **V-9804**
 5.80in H x 2.75in W x 2.05in D (14.73cm x 6.99cm x 5.21cm)
 0.70lbs (0.32kg)



Wire Guard (2 Pack) **V-WGWALL-2**
 12.00in H x 16.50in W x 5.50in D (30.5cm x 41.9cm x 14.0cm)
 2.35lbs (1.10kg)

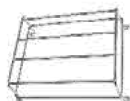

B Signature Series™ Ceiling

For Premium Music Applications

- Exceptional frequency response for voice and music reproduction
- "Pop-On/Pop-Off" volume control knob
- White epoxy finish

Colors: White (Paintable), Custom Colors -CC

One-Way **V-1420 -4**
 13.00in Dia x 3.00in D (33.02cm x 7.62cm)
 3.50lbs (1.59kg)

Accessory:

Speaker Mounting Hardware: M=Metal
HiFi Bridge & Backbox **V-9816M**



D Signature Series™ In-Wall

- Simply recess in a wall
- Paintable for a "hidden" speaker
- White epoxy finish

Colors: White (Paintable), Custom Colors -CC

One-Way **V-1450 -4**
 12.00in H x 8.65in W x 3.20in D
 (30.48cm x 21.97cm x 8.13cm)
 3.00lbs (1.36kg)

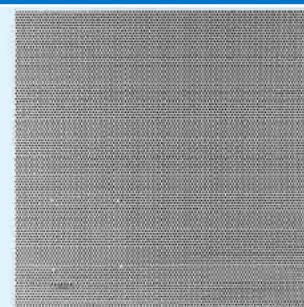

A



B



C



C

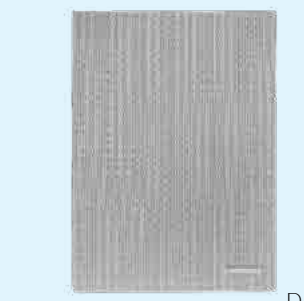

D

The Very Best
 In Music Quality!



High-Fidelity
 Signature Series™



A Slimline™ Speaker

Ideal for offices, clinics, retail, medical waiting rooms and schools

- Excellent voice & music quality . . . good looking . . . good sounding . . .
- Easy install - simply hang on a single screw or use the 2 screw bosses

Colors: Black -BK, Gray -GY, White -W, Custom Colors -CC

One-Way **V-1042** -1
 7.00in H x 10.30in W x 3.40in D (17.78cm x 26.16cm x 8.64cm) 2.80lbs (1.27kg)

Accessory:
Wire Guard (2 Pack) **V-WGWALL-2**
 12.00in H x 16.50in W x 5.50in D (30.50cm x 41.90cm x 14.00cm) 2.35lbs (1.10kg)

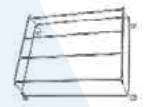

B & C Desktop/Wall Speaker

Reach people while they're on the phone!

- Self-standing - rubber feet prevent movement on a desk surface
- Mount on a wall as a mini-speaker
 - Front cover may be rotated to match positioning on wall
- Off-hook voice announce with handsfree reply
- Volume adjusted with knob on front
- Talkback push button model available

Colors: Black -BK, Gray -GY, White -W
B One-Way 0.70lbs (0.32kg) **V-763** -1

Talkback 0.7lbs (0.32kg) **V-762** 0

Colors: Black -BK, Gray -GY, White -W
C Talkback w/Push Button 0.7lbs (0.32kg) **V-764** 0

3.90in H x 5.10in W x 3.20in D (9.91cm x 12.95cm x 8.12cm)

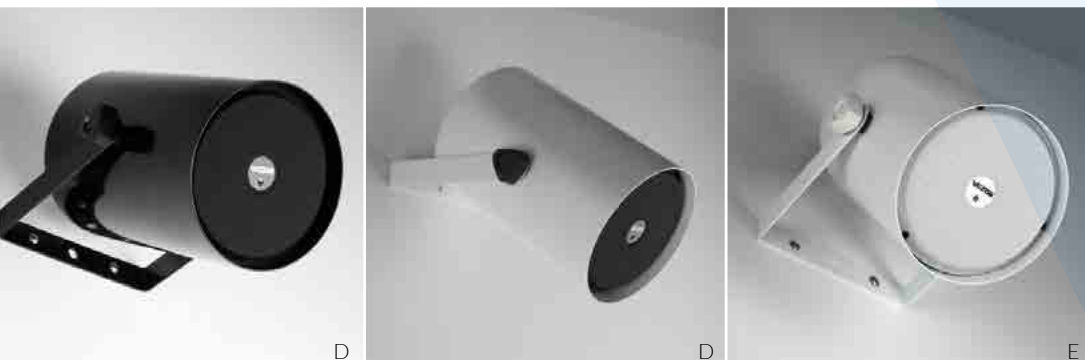

D Track-Style Speaker

Ideal for retail, restaurants, offices, hallways and covered patios!

- High-efficiency speaker
- Metal, weather-resistant enclosure
- Attach track bracket to a wall or exposed beam
- Colors: black, white and custom colors
- Externally accessible volume control
 screwdriver adjustable through hole in grille

Colors: Black -BK, White -W and Custom Colors -CC
1-Watt

D One-Way Black Grill **V-1013B** -1

E One-Way White with White Grill **V-1013B-WW** -1
 5.80in Dia x 8.80in L (14.73cm x 22.35cm) 2.50lbs (1.13kg)

5-Watt
D One-Way Black Grill **V-1014B** -4
 5.80in Dia x 8.80in H (14.73cm x 22.35cm) 3.10lbs (1.41kg)

A Metal Wall Speaker

- Gray with black cloth grille
- Steel with a durable powder coated gray finish
- Easily match any decor by changing color of enclosure
- Easy installation - screw terminal connection
- Excellent voice and music reproduction

Colors: Gray, (Paintable), Custom Colors -CC

IP One-Way, InformaCast®	VIP-410A-IC
IP One-Way or Talkback Programmable	VIP-430A
IP Talkback, InformaCast®	VIP-430A-IC
IP Talkback, Syn-Apps®	VIP-430A-SA

One-Way	V-1052C	1
Talkback	V-1071	0

10.13in H x 12.31in W x 4.63in D (25.73cm x 31.27cm x 11.75cm) 4.25lbs (1.91kg)

Accessory:

Wire Guard (2 Pack)	V-WGWALL-2
---------------------	------------

12.00in H x 14.50in W x 5.50in D (30.50cm x 41.90cm x 14.00cm) 2.35lbs (1.10kg)

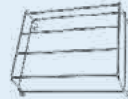

B Metal Wall Corner Speaker

- Corner speaker is mounted up near ceiling to allow for easy wire connection
- 8-inch speaker
- Paintable metal housing (black cloth grille)
- Easy installation - screw terminal connection
- Excellent voice and music reproduction

Colors: Gray, (Paintable), Custom Colors -CC

Talkback	V-1055	0
----------	--------	---

10.00in H x 12.00in W x 4.50in D (25.40cm x 30.48cm x 11.43cm) 3.00lbs (1.36kg)



C Square Wall Speaker

- Line output supports Valcom amplified speakers
- White paintable metal

Colors: White (Paintable), Custom Colors -CC

IP One-Way, InformaCast®	VIP-418A-IC
IP One-Way or Talkback Programmable	VIP-428A
IP Talkback, InformaCast®	VIP-428A-IC
IP Talkback, Syn-Apps®	VIP-428A-SA

One-Way	V-1921	1
Talkback	V-1961	0

11.50in H x 11.50in W x 3.70in D (29.20cm x 29.20cm x 9.40cm) 4.00lbs (1.81kg)

Angled Recessed Surface



Accessories: Optional Backboxes

Angled Mount	VB-A13
--------------	--------

11.63in H x 11.63in W x 4.60in D[t] x 3.15in D[b]

Recessed Mount	VB-R12
----------------	--------

10.75in H x 10.75in W x 3.94in D

Surface Mount	VB-S11
---------------	--------

11.63in H x 11.63in W x 3.94in D

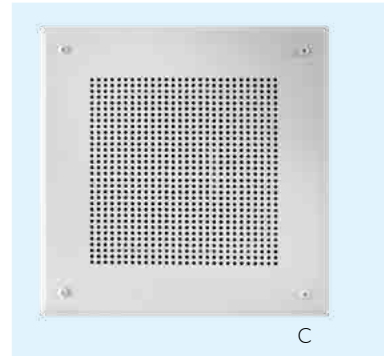



A

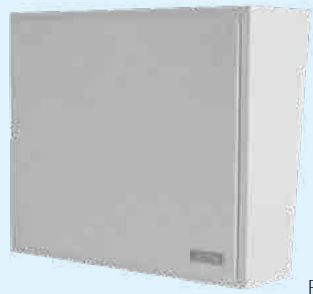

B

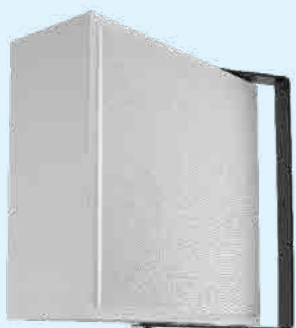

C

Black & White Wall

A Black

One-Way **V-1016-BK** **1**
 9.70in H x 11.50in W x 4.00in D (24.60cm x 29.20cm x 10.16cm) 4.10lbs (1.86kg)

Talkback **V-1061-BK** **0**
 9.60in H x 11.50in W x 4.00in D (24.38cm x 29.21cm x 10.16cm) 4.00lbs (1.81kg)

B White

One-Way **V-1016-W** **1**
 9.70in H x 11.50in W x 4.00in D (24.60cm x 29.20cm x 10.16cm) 4.10lbs (1.86kg)

Talkback **V-1061-W** **0**
 9.60in H x 11.50in W x 4.20in D (24.38cm x 29.21cm x 10.67cm) 4.00lbs (1.81kg)

C White Bi-Directional Corridor

One-Way **V-1026C-W** **1**
 10.30in H x 10.30in W x 4.20in D (26.16cm x 26.16cm x 10.67cm) 5.60lbs (2.52kg) CE

Light Woodgrain Wall *Open-Weave Grille*

D Angled Wall

One-Way **V-1022C** **1**
 9.60in H x 11.50in W x 4.00in D-Top, 3.75in D-Bottom
 (27.31cm x 24.77cm x 12.70cm-T, 9.53cm-B) 4.50lbs (2.04kg)

One-Way, Dual-Input **V-1222** **1**
 10.75in H x 9.75in W x 5.00in D-Top, 3.75in D-Bottom
 (27.31cm x 24.77cm x 12.70cm-T, 9.53cm-B) 4.50lbs (2.03kg)

E Bi-Directional Corridor

One-Way **V-1026C** **1**
 10.30in H x 10.30in W x 4.20in D (26.16cm x 26.16cm x 10.67cm)
 5.60lbs (2.54kg)

Dark Woodgrain Wall *Cloth Grille*

F Angled Wall

One-Way **V-1023C** **1**
 9.60in H x 11.50in W x 4.20in D (24.40cm x 29.20cm x 10.70cm) 4.10lbs (1.86kg)

Talkback **V-1063A** **0**
 9.60in H x 11.50in W x 4.20in D (24.38cm x 29.20cm x 10.61cm) 4.00lbs (1.81kg)

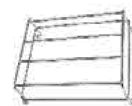

Accessory:

Wire Guard (2 Pack) **V-WGWALL-2**

Works with A, B, D, F

12.00in H x 16.50in W x 5.50in D (30.50cm x 41.90cm x 14.00cm) 2.35lbs (1.10kg)



D



E



F

A Vandal-Resistant Wall Speakers

- Steel-mesh security-baffle prevents objects from penetrating the speaker
- Tamper-resistant faceplate screws resist removal
- Easy mounting to any solid surface
- Heavy-gauge steel construction (Indoor)
- 8-inch self-amplified speaker with adjustable volume
- Gray powder-coat finish, custom colors available on request
Colors: Gray, (Paintable), Custom Colors -CC

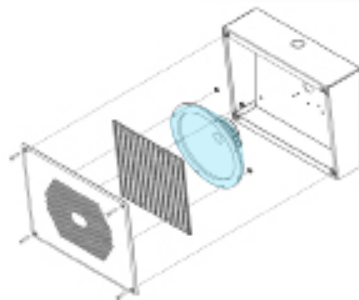

One-Way **V-9852** - 1

Talkback **V-9871** 0
10.00in H x 12.25in W x 4.00in D (25.40cm x 31.12cm x 10.16cm) 8.35lbs (3.80kg)



Vandal-Resistant FlexHorns

- Steel mesh baffle prevents objects from penetrating the speaker
- Tamper-resistant faceplate (screws resist removal)
- Mounting holes for single-gang, double-gang or octagon outlet box or attachment to any solid surface
- Heavy-gauge steel construction with gray powder coat finish, custom colors available on request (Indoor)
- FlexHorn with adjustable volume

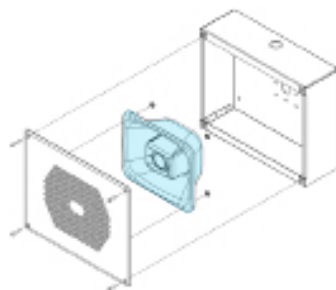

Colors: Gray, (Paintable), Custom Colors -CC

B Surface Mount Unit

IP One-Way or Talkback Programmable **VIP-580A**
IP One-Way, InformaCast® **VIP-580A-IC**
IP One-Way, Syn-Apps® **VIP-580A-SA**

One-Way **V-9880** - 3
Talkback **V-9890** 0

10.00in H x 12.25in W x 4.00in D (25.40cm x 31.12cm x 10.16cm) 8.35lbs (3.80kg)

C Angled Surface Mount Unit

IP One-Way or Talkback Programmable **VIP-581A**
IP One-Way, InformaCast® **VIP-581A-IC**
IP One-Way, Syn-Apps® **VIP-581A-SA**

9.90in H x 12.20in W x 4.00in D-Top 2.70in -Bottom (25.40cm x 30.99cm x 10.16cm)
7.40lbs (3.40kg)

D Bi-Directional FlexHorn Surface Mount Unit

One-Way **V-9885** - 6
10.00in H x 12.25in W x 7.38in D (25.40cm x 31.12cm x 18.70cm) 12.10lbs (5.50kg)

Surface Mount Unit

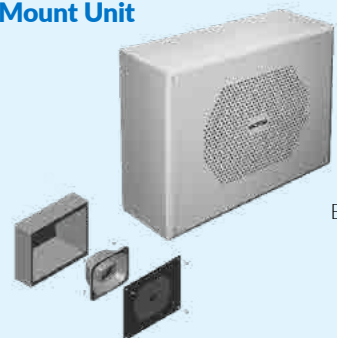

Angled Surface Mount Unit



Bi-Directional Surface Mount Unit Great for Hallways!



For industrial, manufacturing, warehouse areas

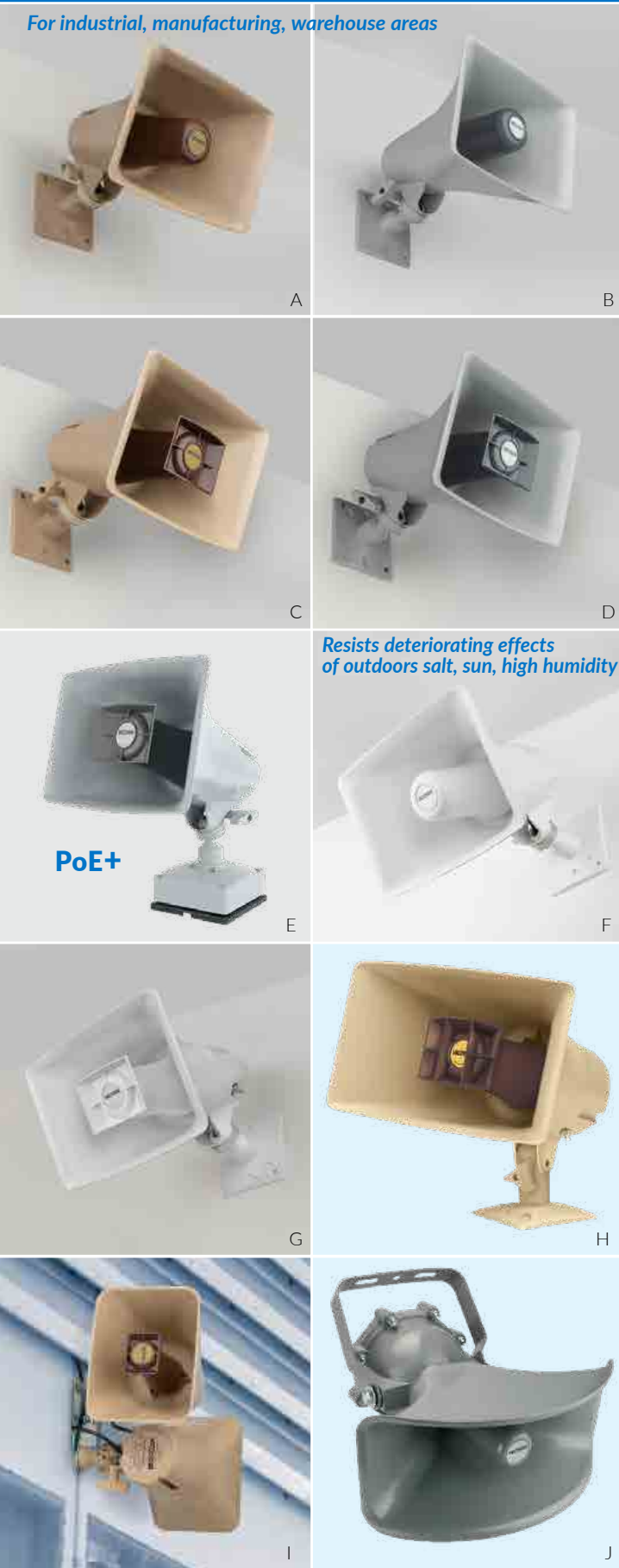

Resists deteriorating effects of outdoors salt, sun, high humidity

PoE+

High-Efficiency Horns

- Very high-efficiency ensures penetration with lower energy consumption
- Features easy Omni-Lock I-Beam clamp mounting system
- Weather-resistant — suitable for indoor or outdoor installation

A	IP One-Way <i>Beige</i>	VIP-130AL-BGE*
	InformaCast® <i>Beige</i>	VIP-130AL-BGE-IC*
	Syn-Apps® <i>Beige</i>	VIP-130AL-BGE-SA*
B	IP One-Way <i>Gray</i>	VIP-130AL-GY*
	InformaCast® <i>Gray</i>	VIP-130AL-GY-IC*
	Syn-Apps® <i>Gray</i>	VIP-130AL-GY-SA*
E	High Power IP Horn, Talkback <i>Gray</i>	VIP-142-GY
	InformaCast® <i>Gray</i>	VIP-142-GY-IC
	Syn-Apps® <i>Gray</i>	VIP-142-GY-SA
A	IP Talkback <i>Beige</i>	VIP-148AL-BGE*
	InformaCast® <i>Beige</i>	VIP-148AL-BGE-IC*
	Syn-Apps® <i>Beige</i>	VIP-148AL-BGE-SA*
B	IP Talkback <i>Gray</i>	VIP-148AL-GY*
	InformaCast® <i>Gray</i>	VIP-148AL-GY-IC*
	Syn-Apps® <i>Gray</i>	VIP-148AL-GY-SA*
C	5-Watt One-Way <i>Beige</i>	V-1030C 5
D	5-Watt One-Way <i>Gray</i>	V-1030C-GY 5
C	15-Watt One-Way <i>Beige</i>	V-1036C 15
D	15-Watt One-Way <i>Gray</i>	V-1036C-GY 15
A	Talkback <i>Beige</i>	V-1048C 0
B	Talkback <i>Gray</i>	V-1048C-GY 0

Marine Horns

- Equipped with O-ring seals
- Features easy Omni-Lock I-Beam Clamp Mounting System

F	IP One-Way <i>White</i>	VIP-130AL-M*
	InformaCast® <i>White</i>	VIP-130AL-M-IC*
	Syn-Apps® <i>White</i>	VIP-130AL-M-SA*
F	IP Talkback <i>White</i>	VIP-148AL-M*
	InformaCast® <i>White</i>	VIP-148AL-M-IC*
	Syn-Apps® <i>White</i>	VIP-148AL-M-SA*
G	5-Watt One-Way <i>White</i>	V-1030M 5
	15-Watt One-Way <i>White</i>	V-1036M 15
F	Talkback <i>White</i>	V-1048M 0

H High-Noise 30-Watt Horn

For high quality voice paging, emergency alerts and loud ringing for large indoor and outdoor areas

One-Way <i>Beige</i>	V-1038 15VDC
----------------------------	---------------------

I Bi-Directional Horns

One-Way <i>Beige</i>	V-1050C 4
----------------------------	------------------

J Explosion-Proof Horn

- Includes V-1092 Volume Control
- Wide-dispersion angle
- UL Listed for use in: Class I, Groups C&D gas atmospheres

One-Way <i>Gray</i>	V-1039A 20
---------------------------	-------------------

Wire Guard for Horns (2 Pack) V-WGHORN-2
(Does not work with H, I, J)



* Long Line Extender

A Stealth Horns

- Houses a Valcom one-way FlexHorn™
- 20-gauge aluminum powder coated cover
- Colors: Architectural Bronze, White -W, Custom Colors -CC

IP One-Way Indoor, Bronze	VIP-9831A
IP One-Way Indoor, White	VIP-9831A-W
IP One-Way Indoor/Outdoor, Long Line Extender, Bronze	VIP-9831AL
IP One-Way Indoor/Outdoor, Long Line Extender, White	VIP-9831AL-W
One-Way Indoor/Outdoor, Bronze	V-9830
One-Way Indoor/Outdoor, White	V-9830-W

9.30in H x 15.00in W x 5.00in D (23.60cm x 39.10cm x 12.75cm) 7.60lbs (3.45kg)



B Stealth Corridor Speaker

- Corridor houses a 6-inch speaker
- Colors: Architectural Bronze, White -W, Custom Colors -CC

IP One-Way or Talkback Programmable Indoor, Bronze	VIP-9815A
IP One-Way, InformaCast® Indoor, Bronze	VIP-9815A-IC
One-Way Indoor, Bronze	V-9815
One-Way Indoor, White	V-9815-W

6.75in H x 15.75in W x 6.75in D (17.10cm x 40.00cm x 17.10cm) 5.20lbs (2.35kg)

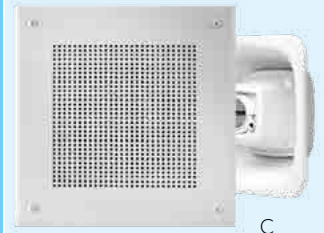

C IP FlexHorn Square Surface Mount Faceplate

- Colors: White, (Paintable), Custom Colors -CC

IP One-Way or Talkback Programmable	VIP-9880A
IP One-Way, InformaCast®	VIP-9880A-IC
IP One-Way, Syn-Appls®	VIP-9880A-SA

10.75in H x 10.75in W x 4.00in D (27.31cm x 27.31cm x 10.16cm) 3.10lbs (1.41kg)

Accessories:

Backbox Recessed Mount	VB-R17-D
-------------------------------------	-----------------

9.63in H x 9.63in W x 5.94in D
(24.46cm x 24.46cm x 15.09cm)



D FlexHorn™

A compact design perfect for:

- Low ceilings such as light manufacturing or multi-floor warehouses
- Low to moderate noise environments
- Perfect solution for gymnasiums, prisons, subways, train stations, schools, drive-thrus, and parking garages
- Water-proof for environments requiring direct spray down such as car washes, food processing plants and operating rooms

Colors: Beige - BG, Gray -GY, White -W

IP One-Way Long Line Extender	VIP-480AL
IP One-Way, InformaCast® Long Line Extender	VIP-480AL-IC
IP One-Way, Syn-Appls® Long Line Extender	VIP-480AL-SA

One-Way	V-1080
Talkback	V-1090

6.80in H x 8.30in W x 3.30in D (17.27cm x 21.08cm x 8.38cm) 2.10lbs (0.95kg)

Mounting Options:

Recessed FlexHorn

The V-1080 and V-1090 can be mounted in wall.



Adjustable Mounting Bracket

V-9804 Included with FlexHorn mount on wall, ceiling, or beam
5.80in H x 2.75in W x 2.05in D
(14.73cm x 6.99cm x 5.21cm) 0.70lbs (0.32kg)



Accessories:

Wire Guard (2 Pack)	V-WGFLEX-2
----------------------------------	-------------------

13.00in H x 14.40in W x 10.50in D
(33.00cm x 27.90cm x 25.40cm) 3.20lbs (1.50kg)



To Make FlexHorns Vandal-Resistant: Indoor

Stainless Steel, Recessed Mount Enclosure & Faceplate	V-9805
--	---------------

8.50in H x 11.00in W x 4.00in D
(21.59cm x 27.94cm x 10.16cm) 7.50lbs (3.40kg)



Stainless Steel, Recessed Mount Faceplate	V-9806
--	---------------

8.50in H x 11.00in W x 0.13in D
(21.59cm x 27.94cm x 0.32cm) 2.00lbs (0.91kg)



Heavy-Gauge Steel, Surface Mount, Gray, Paintable Enclosure & Faceplate	V-9809
--	---------------

10.00in H x 12.25in W x 4.00in D
(25.40cm x 31.12cm x 10.16cm) 7.00lbs (3.20kg)





A

SIP Paging Gateways 200 Series

- Enables voice access to 1 or 4 zones of one-way analog paging plus 8 zones of IP paging
- Designed for use with virtually all SIP based telephone systems
- Live or recorded messages
- 65,000 speakers, expandable to 256 IP paging zones
- Easily connect loudspeaker system To existing computer networks
- Supports IP and analog amplified speakers
- Supports legacy paging systems
- Night ring for SIP systems
- Feedback eliminator store and play

"Session Initiation Protocol (SIP) does not support Multicast. The VE201A and VE204B translate SIP identities to Valcom protocol to allow SIP access of Multicast Groups."

A **1 Zone of one-way analog paging plus 100 Zones of SIP group paging** **VE201A**

- 1 Analog audio output
- 2 Programmable Form C relay closures

B **4 Zones of one-way analog paging plus 100 zones of SIP group paging** **VE204B**

- 4 Analog audio outputs
- 4 Programmable Form A relay closures
- 4 Programmable contact closure inputs

Unicast to Multicast Converter

The Unicast to Multicast Converter is designed for situations where enabling multicast on the WAN is not desirable. The device transmits multicast traffic from one segment of a network to other segments of the network via unicast.

C **Unicast to Multicast Converter Wall Mount** **VEUTM**

D **Unicast to Multicast Converter Rack Mount** **VEUTM-R**

1 Zone of one-way analog paging
8 Zones SIP Paging



B

4 Zones of one-way analog paging
8 Zones SIP Paging



C



D

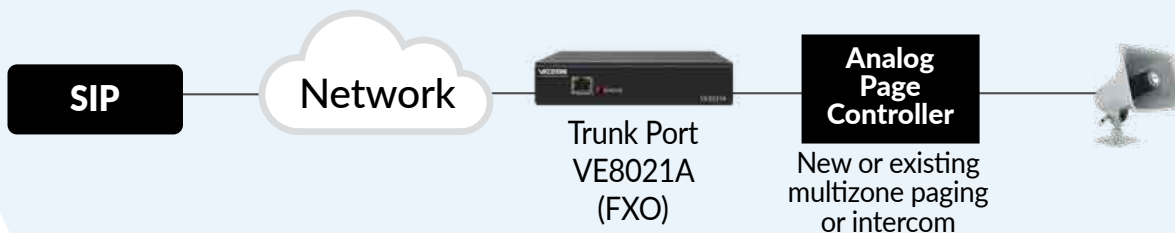

Existing Analog Multi-Zone Paging

- Replaces existing wired FXO connection
- Perfect for any IP telephone system
- Works with hosted IP telephone systems

The VE8021A allows for a SIP connection to an analog multizone intercom or paging system. This is of great benefit to customers who have moved from a traditional analog PBX to an IP telephone system. Simply take the existing FXO port connection and connect it to the line port on the VE8021A.

Connect the VE8021A into a PoE port on the network and register it as a 3rd party SIP extension to your IP telephone system. The customer then dials the SIP extension of the VE8021A. The VE8021A comes off hook and draws dial-tone from the existing intercom or paging system. No reprogramming or retraining is required.

FXO Ports (Loop Start)

Valcom's IP Gateway FXO Ports allows most loop start station ports to be connected to a managed IP-based LAN/WAN. SIP connectivity allows them to act as a gateway device between a SIP telephone system and other Valcom paging systems.

A 1 FXO Port

- 1 RJ-11 FXO
- 1 RJ-11 telephone failover connection

Wall Mount..... **VE8021A**

Rack Mount..... **VE8021AR**

B 2 FXO Ports

- 2 RJ-11 FXO's
- 2 RJ-11 telephone failover connections

Wall Mount..... **VE8022A**

Rack Mount..... **VE8022AR**

C 4 FXO Ports

- 4 RJ-11 FXO's
- 4 RJ-11 telephone failover connections

Wall Mount..... **VE8024A**

Rack Mount..... **VE8024AR**

D SIP Intercom Controller..... **VE8090R**

The VE8090R SIP Intercom Controller provides access to Valcom VoIP audio endpoints from SIP (Session Initiation Protocol) telephone servers. The SIP Intercom Controller can communicate with the SIP telephone server as either registered SIP stations or as a SIP trunk. The SIP Intercom Controller supports up to four concurrent calls for any combination of talkback intercom or group paging per call. Two FXS ports are available to facilitate POTS telephones, Loop Start Trunk or FXO port access. The VE8090R is designed for rack mounting.

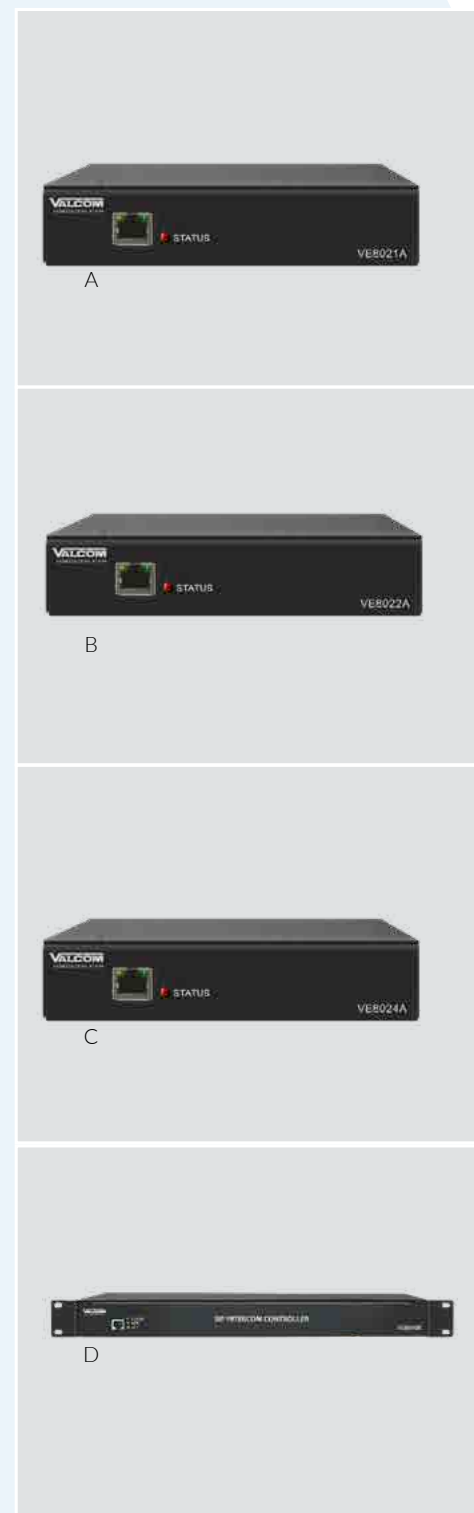

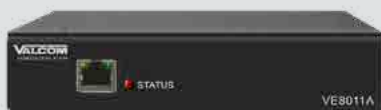
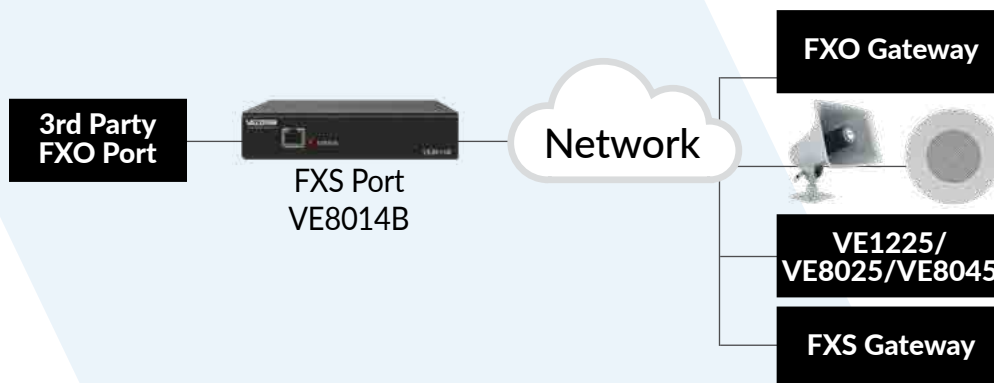

A

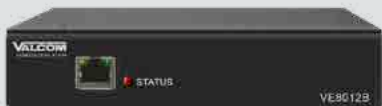

B

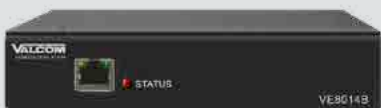

C

FXS Ports (Station Ports)

Valcom's IP Gateway FXS Ports enables telephones to engage in paging and phone-to-phone communications over an IP-based network.

A 1 FXS Port

- 1 RJ-11 FXS port
- 2 programmable form C relay contacts

Wall Mount..... [VE8011A](#)
Rack Mount..... [VE8011AR](#)

B 2 FXS Ports

- 2 RJ-11 FXS's
- 4 programmable form C relay contacts

Wall Mount..... [VE8012B](#)
Rack Mount..... [VE8012BR](#)

C 4 FXS Ports

- 4 RJ-11 FXS's
- 4 programmable form C relay contacts
- Provides caller ID signaling

Wall Mount..... [VE8014B](#)
Rack Mount..... [VE8014BR](#)

Need an Administrative Telephone?
Call us about the [VEADP4](#)

Configuration of Valcom SIP Paging is through the VIP-102B IP Solutions Setup Tool

Download the latest version of the free IP Solutions Setup Tool from www.valcom.com/vipsetuptool

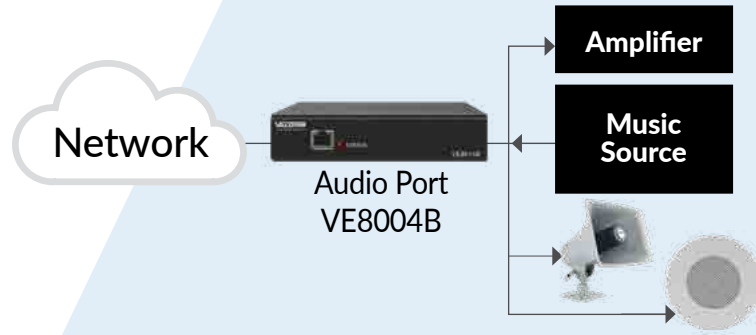

Audio Ports (Line Level -10dbm)

Enables voice access to one-way paging over an IP-based network. This allows page zone extension anywhere on the network. It can also be programmed as a SIP device for connectivity to virtually any VoIP telephone system. Audio ports are inputs or outputs. They may be connected to line level audio sources or line level audio inputs.

A 1 Audio Port

- 1 audio output and input
- 1 contact closure input
- 2 programmable form C relay contacts

Wall Mount **VIP-801A**

Rack Mount **VE8001AR**

InformaCast® **VIP-801A-IC**

Syn-Apps® **VIP-801A-SA**

B 2 Audio Ports

- 2 audio outputs and inputs
- 2 contact closure inputs
- 2 programmable form A relay contacts

Wall Mount **VIP-802B**

Rack Mount **VE8002BR**

C 4 Audio Ports

- 4 audio outputs and inputs
- 4 contact closure inputs
- 4 programmable form A relay contacts

Wall Mount **VIP-804B**

Rack Mount **VE8004BR**



Paging multiple floors in a single building

Paging multiple buildings in a campus environment

City-wide paging of all Fire & Rescue buildings

Interstate paging between bank branches

Relay information rapidly!

Send live voice, pre-recorded, wav files, and text with the TOUCH of a button



Emergency Notifications

Quickly activate emergency alerts

you can communicate to multiple departments or issue a targeted emergency message

PIN code access for security protection

Only authorized staff can access the system

Public Address/Paging

Streamline daily communications

with one touch of a button

Send recorded audio

Everyday repetitive tasks like announcing "go to lunch period 1" is easier with one touch of a button

Send live voice

You can always do messages on-the-fly

Send wav files

Play Brahms Lullaby when a baby is born

Send text

Visual notifications to LED signs and Desktop Alerting

Intercom calls

to Valcom IP speakers and horns

Interactive Console **VIP-893**

Interactive Console with Scheduling **VIP-893-S**

Scheduler Firmware Upgrade for customers with VIP-893 **L893-S**

10.1 inch color touch screen



Programming buttons specific to your facilities needs

Adjustable display tilt



Adjustable for different environments

Microphone and speaker



Built-in speaker for PA announcements

Non-skid base



PoE+ or 12Vdc powered

IP retrofit for existing analog intercom systems



A 8 Port 25 Volt Talkback Gateway VE8025

The VE8025 allows for the ultimate modernization of old fashioned 25 volt intercom systems. It provides 8 two-way intercom channels for use with 25 volt speakers and 8 call button inputs. Stations 7 and 8 feature both two-way audio outputs and parallel line level outputs. These line level outputs may be connected to amplifiers or self-amplified speakers in order to provide one-way audio to common areas. PoE makes installation as easy as plugging in an RJ45 from an 802.3af compliant power over Ethernet switch. The override audio input may be triggered via VOX or contact closure. System relays may be utilized for visual signaling during announcements or for door unlock functionality. System capacity is virtually unlimited.



B 8 Port 45 Ohm Talkback Gateway VE8045

The VE8045 provides same features as the VE8025 but for use with 45 Ohm speakers.

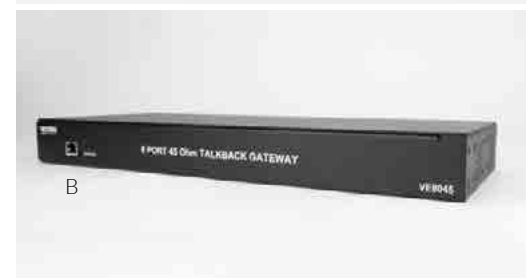

C 12 Port Talkback Gateway VE1225

The VE1225 provides 12 two-way intercom channels each supporting either 2, 45 Ohm speakers or a 15-Watt load of 25 volt speakers. The unit conveniently features 12 call button inputs as well as dual line level outputs. These line level outputs may be connected to amplifiers or self-amplified speakers in order to provide one-way audio to common areas. AC power makes installation as easy as plugging in a common AC receptacle. System relays may be utilized for visual signaling during announcements or for door unlock functionality. 12 Port Retrofit Gateway channels may be directly accessed via Session Initiation Protocol (SIP).



Power options for the VE1225:

Cordset, United Kingdom (BS1363) V-UKCS

Cordset, European (Type C) V-EVCS



IP retrofit for existing 25 V amplifiers



D SIP 20-Watt Gateway 25 V VIP-851-25 InformaCast® VIP-851-25-IC

Valcom's VIP-851-25, SIP 20-Watt Gateway 25 V enables voice access to a single zone of one-way paging over an IP network, allowing page zones to be extended anywhere network connectivity is available. The VIP-851-25 can be programmed as a SIP (Session Initiation Protocol) device for connectivity to virtually any VoIP (Voice over IP) telephone system. The VIP-851-25 has output connections for line level and 25 V speakers only.



E SIP 20-Watt Gateway 25/70/100 VIP-851-70/100 InformaCast® VIP-851-70/100-IC

Valcom's VIP-851-70/100, SIP 20-Watt Gateway 25/70/100 V enables voice access to a single zone of one-way paging over an IP network, allowing page zones to be extended anywhere network connectivity is available. The VIP-851-70/100 has output connections for line level and 25 V, 70 V or 100 V speakers.



Loaded with features!

Automated daily communication

Emergency notification

Calendar event scheduling

Graphical interface
for easy point-and-click
message initiation



VEIP6K-1 Communications Package Overview

Valcom IP systems can be as simple as an IP speaker accessed directly from an IP phone system or as complex as a multisite emergency mass notification system with 1000s of IP speakers, horns, LED signage, email alerts, PC screen alerts and strobes.

Most systems are accessed by Session Initiation Protocol (SIP) and/or FXO ports, have integration to a small number of analog systems or speakers, have switch inputs to activate emergency messages, and have relays to interface with access control systems or other non-Valcom systems.

Other very common features include bell schedules, pre-recorded audio messages, email alerts and a GUI control/management interface.

The **IP6K Headend Package** is a perfect starting point for most systems as it provides all these most common features in a convenient 19-inch (48.26 cm) 3 rack unit* package.

Additional gateways, IP speakers, clocks and IP LED signs may be added to your Valcom system as required for your specific application.

3 rack unit

*A rack unit (abbreviated U or RU) is a unit of measure defined as 1 3/4 inches (44.45 mm). It is used as a measurement of the overall height of 19-inch frame. Equipment is typically 1U, 2U or 3U in height.

Valcom IP Systems gives the ability

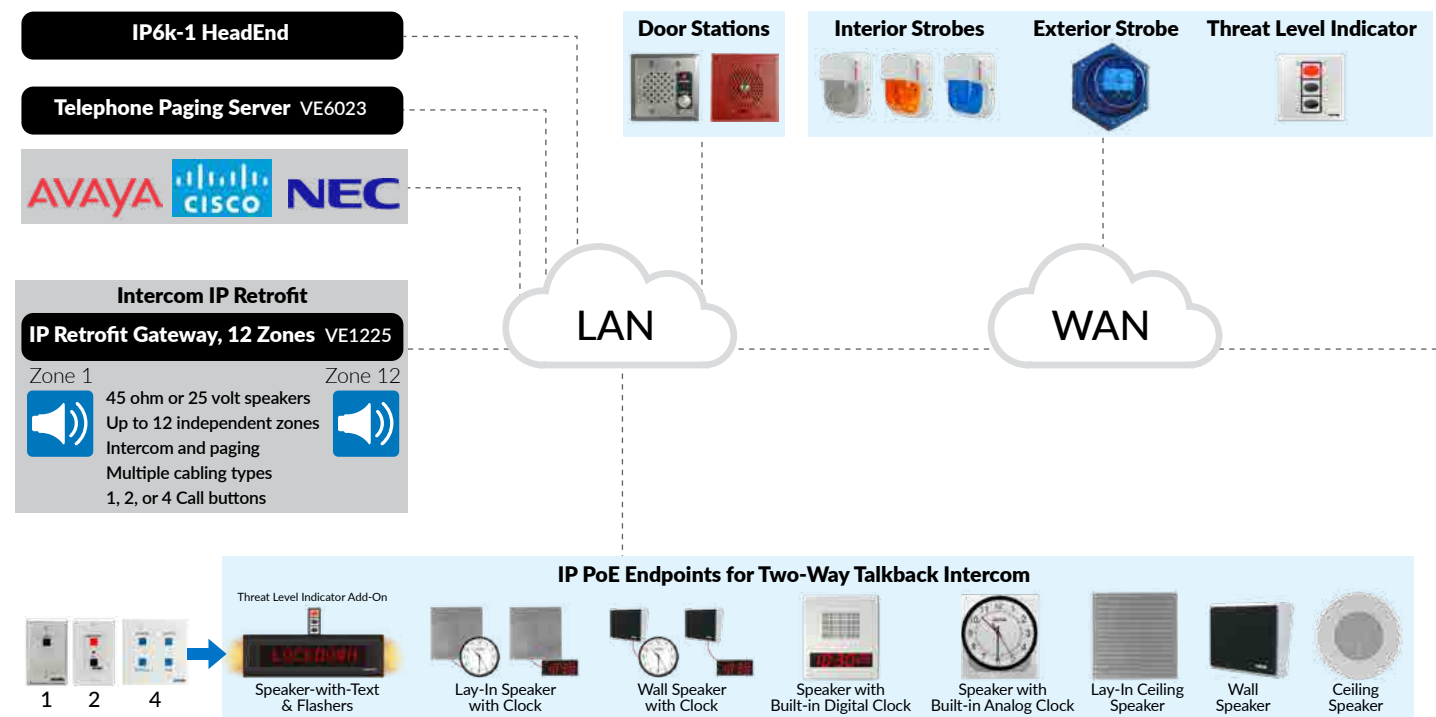

Individual IP6K HeadEnd Components



A Communication/Notification Server with UPS battery backup
2 rack unit (RU) **VE6030-1**

The VE6030-1 provides enhanced browser accessible features such as automated daily communication, emergency notification, calendar event scheduling, a graphical interface for easy point-and-click message initiation and on demand distribution of WAV files. The unit provides multiple calendar-based event schedules featuring one-second resolution.

Pre-recorded audio, and/or pre-defined text messages* may be simultaneously delivered to groups of speakers, LED signs, email recipients, computer displays and the speaker and displays of select IP telephones. A convenient browser accessible Windows® PC allows remote access of any PC based software tools required to maintain the system.

The VE6030-1 is capable of sending and receiving CAP (Common Alerting Protocol) messages and executing multiple emergency voice and predefined text messages* and from key words of one or more CAP message files.

The VE6030-1 includes a UPS that provides continued operation during power failures. The UPS automatically and gracefully shuts down the VE6030-1 after an extended power loss so the Communication Notification Software is fully operational when power is restored.

*Text messages use Valcom protocol and are not SMS messages. The VE6030-1 and VE6090-1 can only send SMS messages as e-mail if such services are locally available.

B Communication/Notification Server with voice interface with SIP and UPS battery backup
2 rack unit (RU) **VE6090-1**

The VE6090-1 includes the VE6030-1 Communications/Notification Server and a VE8090R SIP Intercom Controller [page 15] on a single rack mount shelf. It provides phone access to Valcom IP endpoints from SIP stations, SIP trunks, stand-alone analog telephones, loop start trunk, or FXO ports. Support for up to four simultaneous calls for intercom, and one-way page announcements is standard. Caller ID provides caller identifications when calls are received from Valcom two-way speakers/intercom stations.

C Aux Audio I/O Controller 1 rack unit (RU) **VE4804**

The Auxiliary Audio I/O Controller includes a VE8048A IP Network Input/Output Module and VE8004B IP Audio Port [page 17]. It provides 8 software-controlled form A control relays, 8 switch inputs for launching emergency messages from panic buttons or other facility systems, 4-line level audio input/outputs for sending system audio to Valcom self-amplified speakers or old-style central amplifiers, or for adding analog audio sources to the IP system.

to scale to any size for any place

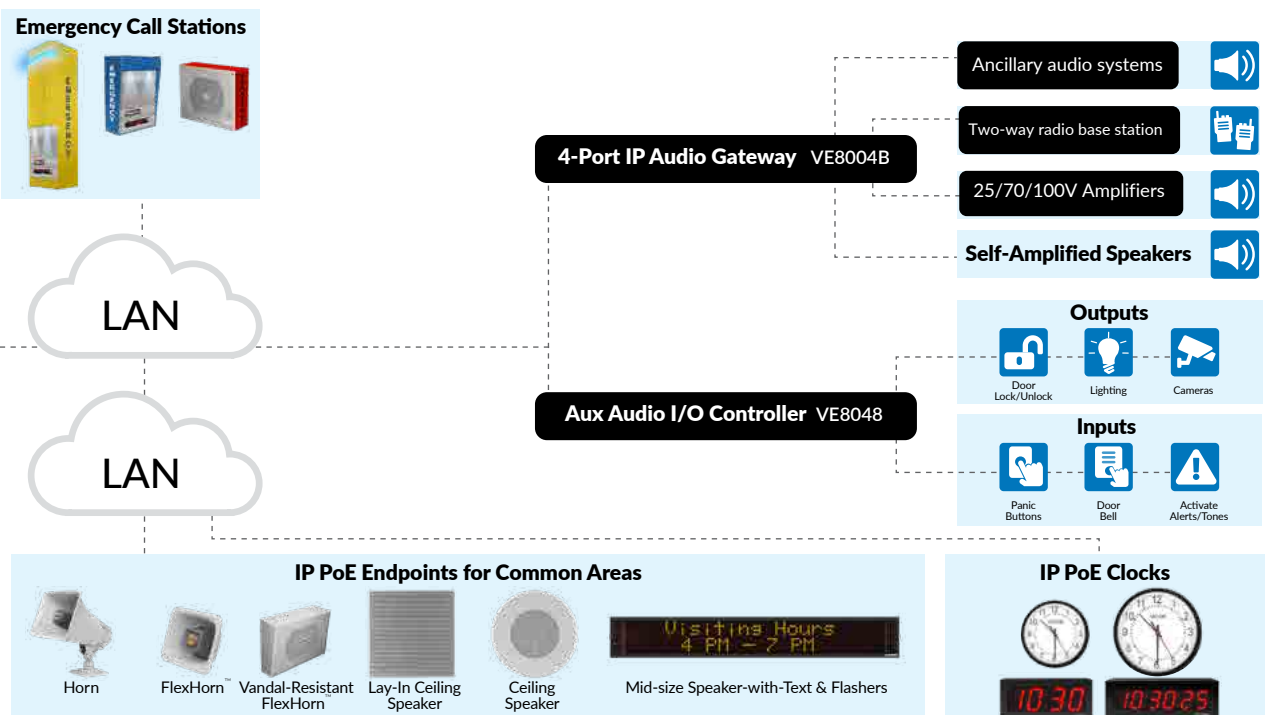

AVAYA

CISCO

NEC



A

Receive emergency or daily announcements over your existing IP phones

The VE6023 Telephone Paging Server, when used as part of Valcom's IP6000 Communications System, provides live and automated emergency messaging, event scheduling, audio and text to compatible IP telephones. The server allows distribution of audio and text to an unlimited number of IP telephones. The simple browser-based interface facilitates programming of compatible IP telephone systems.

COMPATIBLE WITH

Cisco Communications Manager versions 5+ and paging-enabled Cisco IP Telephones

Avaya Communication Manager and paging-enabled Avaya IP Telephones

NEC DT800 and DT900 Series IP Telephones

- Provides audio and text to compatible IP telephones (additional equipment required)
- Send alerts to the speakers of select IP telephones (additional equipment required)
- 1U server
- Web browser access to setup and real-time control functions
- Any phone may be in any number of groups
- Telephone groups and speaker groups synchronized
- Emergency priority override feature on compatible telephones
- System backup and restore
- Communicates with VIP-102B Setup Tool [downloadable from www.valcom.com/vipsetuptool for many of our IP products] for setup and group information
- High availability redundancy with tandem VE6023

Page through IP Phone Speakers

A Telephone Paging Server **VE6023**

Send audio to Valcom IP speakers and IP phones

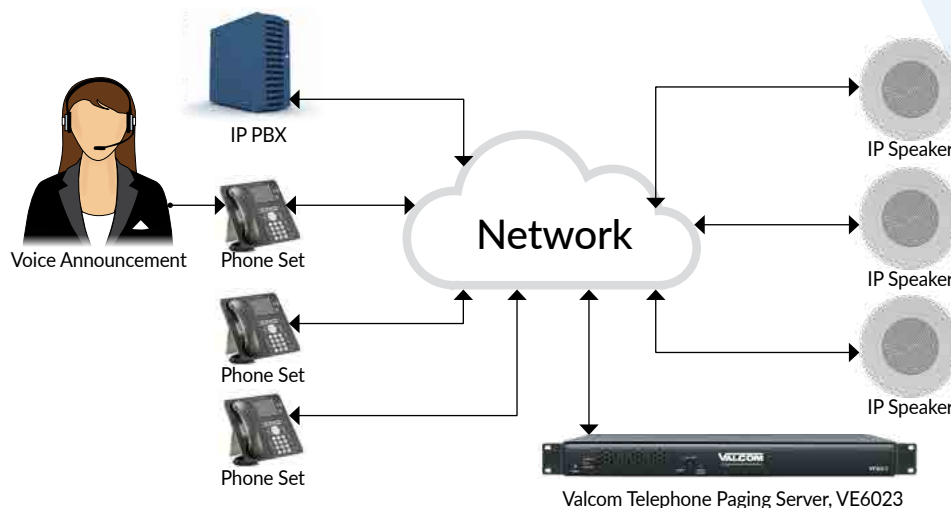

Universal Paging Interface provides access to virtually any paging system from a variety of phone system connections. Designed for quick and easy installation.

- Use with Valcom multi-zone page units
- Use with Valcom talkback page units
- Background music mutes during page
- Customizable pre-page alert tone
- Music and tones volume controls
- Feedback elimination
- Multiple disconnect options
- Security code option
- SIP compatible
- Requires a power supply
- Multiple units can be connected in tandem
- Web interface
- SIP expanded to 4 extensions with Night Ring and Store & Play on all lines

1 Zone

FXS Extension, PBX Station Extension, Electronic Key Line, PBX Loop Start Trunk Port, Standard Telephone, SIP



A

Analog or SIP Based Paging Interface

A **Universal Paging Interface with Licenses** **V-9972-2**

9.25in W x 10.12in D x 1.72in H (23.49cm x 25.70cm x 4.36cm) 2.50lbs (1.13kg)

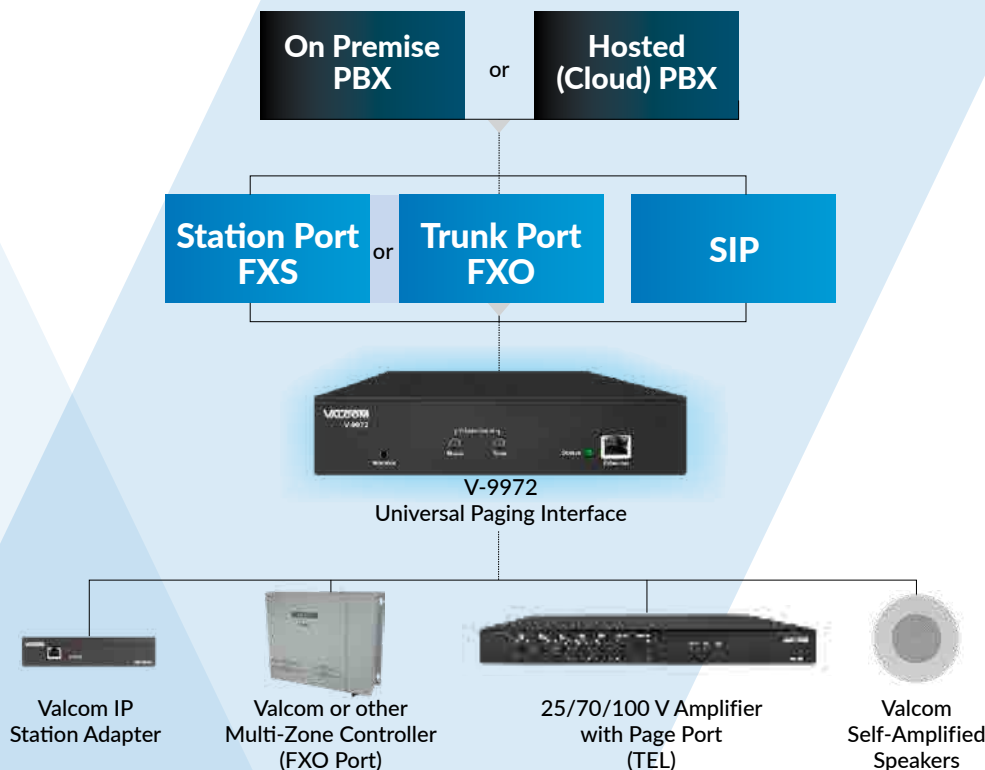



A

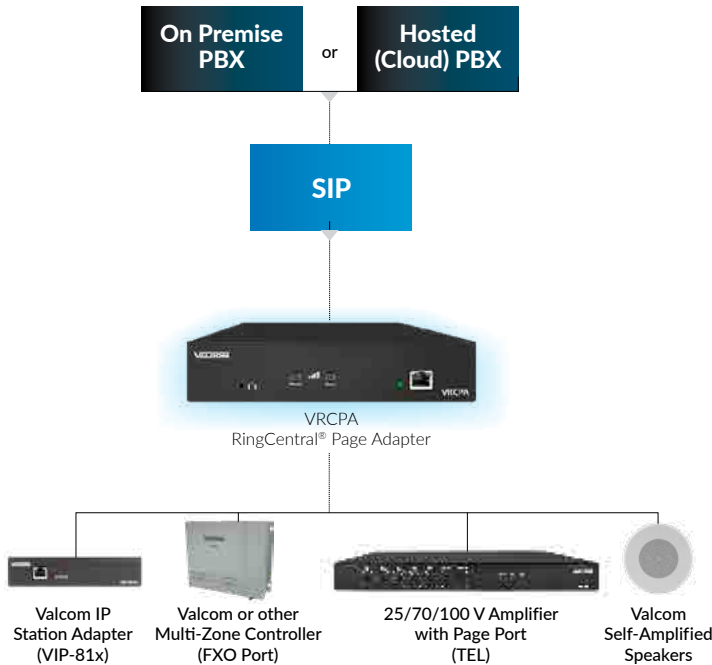

A RingCentral® Paging Adapter

Seamlessly connects RingCentral users to their new or existing public address systems.

Valcom's VRCPA RingCentral® Paging Adapter is designed to provide access to paging systems from RingCentral hosted Session Initiation Protocol (SIP) voice over IP (VoIP) connections, or through analog trunk or station inputs (FXO/FXS).

When paired with RingCentral SIP connections the VRCPA supports Valcom handsfree page units for talkback paging and up to 150 Valcom one-way amplified speakers. The VRCPA can connect multiple units for multi-zone paging.

SIMPLY CONNECT:

Any Legacy 25/70 Volt system

Valcom analog one-way or talkback systems

Valcom IP speaker/horn endpoints

Self-amplified speakers/horns

RingCentral Paging Adapter Power supply included ... **VRCPA-12**

9.25in W x 10.12in D x 1.72in H (23.49cm x 25.70cm x 4.36cm) 2.50lbs (1.13kg)

Input/Output Module



B



B IP Network Input/Output Module Wall Mount..... **VE8048A**

IP Network Input/Output Module Rack Mount..... **VE8048AR**

You can easily control and monitor virtually any type 3rd party system and device with the 8 input, 8 output contact controller. Multiple devices can easily be connected and controlled via schedules or during emergencies.

- 8 relay outputs
- 8 contact closure inputs
- RJ-45 for network connection
- Front panel activity LED
- Removable terminal block connectors provided for input and relay connections
- 2.5mm jack for DC power (optional)
- Power over Ethernet (PoE) 802.3af compatible

IP Network Input/Output Module

InformaCast®..... **VIP-848AR-IC**

Syn-Apps®..... **VIP-848AR-SA**

2000 Series™
POWER INCLUDED

A 1 Zone ◆▲ Basic zone or area of paging

The Valcom V-2000A is an integrated Single Zone Page Control Unit and provides telephone access to a single zone. The V-2000A is equipped with a background music port and is voice activated music mute when it is initiated. The V-2000A drives audio up to 150 Valcom one-way self amplified speakers and has the ability to mute background music when a voice activated page is performed.

One-Way **V-2000A +12**
2.50in H x 7.70in W x 5.30in D (6.35cm x 19.56cm x 13.46cm) 2.60lbs (1.18kg)

B 1 Zone Enhanced ◆▲ Phantom Zone™ allows paging to all speakers but limits music to selected speakers

Valcom's V-2001A One Zone, One-Way Enhanced Page Control Unit is an integrated page control unit equipped with a power supply to provide additional power to Valcom self-amplified speakers and horns. The built-in tone generator (single and warble) allows for night rings and break tones after normal business hours. The V-2001A enables you to do emergency page overrides for priority announcements.

One-Way **V-2001A +20**
One-Way European Version* **V-2001A-E +20**
7.06in H x 9.00in W x 2.40in D (17.93cm x 22.86cm x 6.10cm) 3.70lbs (1.68kg)

*International Version - Power Requirements: 230 Vac/.5A

C 3 Zones ◆■▲ Three zones of one-way paging plus all call

Valcom's V-2003A Three Zone, Page Control Unit provides telephone system access to three zones of one-way paging and has built in tones for steady, warble and alert. The V-2003A allows you to conduct an emergency page override for priority messages. The AHF version enables you to access 3 zones for handsfree talkback capability.

One-Way **V-2003A +20**
7.10in H x 10.00in W x 3.00in D (18.03cm x 25.4cm x 7.62cm) 4.10lbs (1.86kg)
One-Way European Version* **V-2003A-E +20**
7.10in H x 10.00in W x 3.00in D (18.03cm x 25.4cm x 7.62cm) 4.10lbs (1.86kg)
Talkback **V-2003AHF +10**
7.10in H x 10.00in W x 3.00in D (18.03cm x 25.40cm x 7.62cm) 5.60lbs (2.54kg)

*International Version - Power Requirements: 230 Vac/.5A

D 6 Zones ◆■▲ Six zones of one-way paging, all call, 3 programmable zone groups

Valcom's V-2006A, Six Zone, Page Control unit that allows the user to page six individual zones of one-way paging and all call. The built-in tone generator enables you to notify with individuals through a variety of tones indicating various events such as break time. The V-2006A also has an emergency page override for priority messages so you can alert individuals of emergency or priority notifications.

One-Way **V-2006A +30**
10.90in H x 13.00in W x 2.70in D (27.69cm x 33.02cm x 6.86cm) 6.20lbs (2.81kg)
One-Way European Version* **V-2006A-E +30**
10.90in H x 13.00in W x 2.70in D (27.69cm x 33.02cm x 6.86cm) 6.20lbs (2.81kg)
Talkback **V-2006AHF +20**
10.90in H x 13.00in W x 2.70in D (27.69cm x 33.02cm x 6.86cm) 7.50lbs (3.40kg)

*International Version - Power Requirements: 230 Vac/1.0A

PBX Loop Start Trunk, Electronic Key Line, Single Line Phone

E 1 Zone ◆

Talkback **V-9941A** ⑤
8.25in H x 4.65in W x 2.30in D (20.96cm x 11.81cm x 5.84cm) 1.50lbs (0.68kg)

F Station Level/FXS Adapters

1 Zone ●

Talkback **V-9940** ④
8.20in H x 4.55in W x 2.30in D (20.83cm x 11.56cm x 5.84cm) 1.70lbs (0.77kg)

G PagePal Interface ◆■▲● **V-5335700** ①

2.50in H x 6.00in W x 4.00in D (6.35cm x 15.24cm x 10.16cm) 2.00lbs (0.91kg)



Telephone Access	FXO	PBX Loop Start Trunk Port Electronic Key Line Position Dedicated Single Line Phone Set	◆
	FXO	PBX Ground Start Trunk Port	■
	Audio Port	Page Port (Telephone System Dependent)	▲
	FXS	Centrex or C.O. Line PBX Analog Station Port (Loop Disconnect Required)	●

Look for these orange symbols when selecting page controls

Step 1

Easy Selection Considerations

Number of zones

One-way broadcast only
or

Talkback (includes one-way)

Two-way handsfree

Special features

Select a Page Control

		One-Way Page Controls				Talkback Page Controls	
		V-2000A	V-2001A	V-2003A	V-2006A	V-2003AHF	V-2006AHF
Features	Number of Zones	1	1	3	6	3	6
	Background Music	•	•	•	•	•	•
	All Call	•	•	•	•	•	•
	Group Call				•		•
	Emergency Page Override		•	•	•	•	•
	Night Ring/Time Clock Tones		•	•	•	•	•
	Valcom Power Units Provided	+ 12	+ 20	+ 20	+ 30	+ 10	+ 20
Telephone Access	FXO PBX Loop Start Trunk Port Electronic Key Line Position Dedicated Single Line Phone Set	◆	•	•	•	•	•
	FXO PBX Ground Start Trunk Port	■		•	•	•	•
	Audio Port Page Port (Telephone System Dependant)	▲	•	•	•	•	•
	FXS Centrex or C.O. Line PBX Analog Station Port (Loop Disconnect Required)	●	Add V-9972				Add V-9972 or Add V-9940

Look for these orange symbols when selecting page controls

Step 2

Easy Selection Considerations

Style, decor & color

Indoor, outdoor or industrial environments

One-way or talkback

Area to be paged in square feet

Determine ceiling heights & type

Noise levels

Speaker/Horn Placement Guide

Shows SPACE Between Horns & Square Foot Coverage PER Horn

Speakers	Ceiling Height x 2 = Speaker Placement Example: 8ft Ceiling x 2 = Space Speakers 16ft Apart	Horns	5-Watt	15-Watt	30-Watt	Quiet	Moderate	Noisy	Very Noisy
						50-65dB	65-80dB	80-90dB	90+dB
			110ft (12,000sq.ft)	80ft (6,400sq.ft)	50ft (2,500sq.ft)	30ft (900sq.ft)			
			-	-	75ft (5,600sq.ft)	45ft (2,000sq.ft)			
			-	-	-	60ft (3,600sq.ft)			
Power Pair Run									
Number of Speakers/Horns Per Power Run					Power Run Wire Length in Feet				
# Interior Speakers	Signature Series™	Flex Horns	5-Watt Horns	15/30-Watt Horns	24 AWG	22 AWG	20 AWG	18 AWG	16 AWG
4	1	-	-	-	1000ft	1600ft	2500ft	4000ft	6400ft
7	2	1	1	-	500ft	800ft	1280ft	2025ft	3220ft
15	4	2	2	-	250ft	400ft	640ft	1010ft	1610ft
30	8	4	4	1	125ft	200ft	320ft	500ft	805ft

Step 3

Valcom Power Units VPU's — Make it easy!

Easy Selection Considerations

The amount of power required for a paging system is based on the quantity and type of page control and speakers/horns selected.

Valcom Products are Assigned Valcom Power Units (VPU)

Products Either Provide + #

or Consume - # Power

Simply Total All:

- Page Control VPU's
- Speaker/Horn VPU's
- Subtract b. from a.

Example:

$$\begin{aligned} \text{Page Control } 1 \times +30 &= + 30 \text{ VPU Provided} \\ \text{Speakers } 15 \times -1 &= - 15 \text{ VPU Consumed} \\ &= + 15 \text{ VPU's LEFT OVER} \end{aligned}$$

NO Additional Power Supply needed!

- Products that neither consume NOR provide power are a 0
- Note: one Valcom Power Unit = 50mA., -24 Vdc
- VPU listings are on the product pages & index

- Have VPU's left over - You can add more speakers!
- Need more - Simply select a Power Supply with enough VPU's to make up the difference!

Digital Power Supplies with Long Life Capacity!

- Smaller footprint — Less energy/less heat
- Barrel to wire connection
- Wall, rack/rail mount, mounting bracket included

A	300 mA/24 V	VP-324D +6
	2.48in H x 1.73in W x 1.08in D (7.21cm x 4.40cm x 2.74cm) 0.20lbs (0.09kg)	
B	600 mA/24 V	VP-624D +12
	1.42in H x 1.50in W x 3.58in L (3.60cm x 3.80cm x 9.10cm) 0.36lbs (0.17kg)	
C	1 Amp/24 V	VP-1124D +20
	European Version.....	VP-1124D-EC +20
	UK Version.....	VP-1124D-UK +20
	1.22in H x 1.65in W x 4.11in L (3.10cm x 4.60cm x 9.90cm) 0.40lbs (0.20kg)	
D	2 Amp/24 V	VP-2124D +40
	European Version.....	VP-2124D-EC +40
	UK Version.....	VP-2124D-UK +40
	1.38in L x 1.93in W x 4.45in L (3.70cm x 2.35cm x 12.10cm) 0.60lbs (0.30kg)	
E	2 Amp/48 V For V-1038, 30-Watt Horn, page 18.....	VP-2148D N/A
	1.50in L x 2.60in W x 6.61in L (3.90cm x 6.60cm x 16.80cm) 1.10lbs (0.50kg)	
F	4 Amp/24 V	VP-4124D +80
	European Version.....	VP-4124D-EC +80
	1.57in H x 2.56in W x 7.05in L (3.60cm x 6.70cm x 16.90cm) 1.15lbs (0.52kg)	

Switching Digital

- Three outputs, 2 Amps each
- Regulated and filtered
- Floating output
- Input fuse protected
- Output protected
- Wall mount plate included

G	6 Amp/24 V	VP-6124 +120
	European Version/230 Vac /.86A; 165-Watt.....	VP-6124-E +120
	6 Amp/24 V	VP-6124-P +120
	10.30in H x 5.92in W x 2.50in D (26.16cm x 15.04cm x 9.53cm) 5.00lbs (2.27kg)	
	Power Supply Shelf	VP-9202 N/A
	Holds two VP-6124 power supplies in a standard 19-inch rack (Not pictured) 12.50in H x 19.00in W x 3.75in D (31.75cm x 48.26cm x 9.53cm) 5.40lbs (2.30kg)	
H	12 Amp/24 V	VP-12124 +240
	12.10in H x 8.70in W x 3.90in D (30.70cm x 22.10cm x 9.90cm) 7.70lbs (3.50kg)	

Back-Up Power

I	Battery Back-Up Power	VPB-260 N/A
	<ul style="list-style-type: none"> • Contains long life maintenance-free gel cell batteries • Fuse-protected AC input, current limiting on output 9.25in H x 7.50in W x 5.25in D (23.50cm x 19.00cm x 13.30cm) 19.00lbs (8.60kg)	
J	Battery Back-Up Charger	VP-6124-UPS 0
	<ul style="list-style-type: none"> • Permits system operation in event of AC power failure • For use with VP-6124 Power Supply/VBB-1424 10.30in H x 3.50in W x 2.25in D (26.16cm x 8.89cm x 5.72cm) 2.90lbs (1.32kg)	
K	Battery Box with Batteries	VBB-1424 0
	<ul style="list-style-type: none"> • Complete your UPS system with battery support • For use with VP-6124 / VP-6124-UPS 5.52in H x 8.03in W x 10.82in D (14.02cm x 20.40cm x 27.48cm) 17.50lbs (7.88kg)	

Special Purpose

L	400 mA/12 V Unfiltered	VP-412A N/A
	2.60in H x 2.00in W x 2.30in D (6.60cm x 5.08cm x 5.84cm) 0.70lbs (0.32kg)	

IP Local Power Option for VoIP Products

M	IP 24 Vdc, 300mA Receptacle Mount.....	VIP-324D
	2.84in H x 1.73in W x 1.08in D (7.21cm x 4.39cm x 2.74cm) 0.20lbs (0.09kg)	

International Cordsets

United Kingdom Cordset.....	V-UKCS
European Cordset.....	V-EUCS



300 mA/24 V



A

600 mA/24 V



B

1 Amp/24 V



C

2 Amp/24 V



D

2 Amp/48 V



E

4 Amp/24 V

4 Amp unit also includes low energy screw terminal connecting block



F

6 Amp/24 V



G

12 Amp/24 V



H

Battery Back-Up Power



12 and 24 Volts DC, fused at 3 Amp

I

Back-Up Charger



J

Battery Box



K

400 mA/12 V



L

IP Power Supply



M

230 Vdc Power Supplies:

- EC European Power Supply (Plug Included)
- UK United Kingdom Power Supply (Plug Included)

ACS

by Valcom

Advanced Communication System



24 - 72 Zones

Ideal for Schools, Institutions, Industrial, Healthcare Facilities, Airports

The ACS is a compact and scalable system for daily and emergency communications. The ACS is installed with Valcom's easy-to-use software that provides the user with flexibility to program multiple zones from anywhere on your network. From the comfort of your own desktop PC you have the ability to control your entire facility's daily communication and instantly alerts individuals with urgent information during an emergency, or communicate with a specific area without disturbing others.

FEATURES

- 24 flexible zone grouping**
- Bell schedules** – Standard calendar base
- Custom WAV file support** – Standard up to 1 hour
- Clock correction** 2-wire digital and 59th minute
- Windows-based programming & administration**
- Integrated power**
- Talkback speaker support** – 45 Ohm or 25 V
- 2 music inputs**
- 24 station zone capacity** – Expandable to 72

Expandable Intercom System up to 72 Zones

25 V

25 V **V-ACS25**

Expands the V-ACS25 to 48 Zone **V-ACS-X48/25**

Expands the V-ACS25 to 72 Zone **V-ACS-X72/25**

16.15in W x 10.375in H x 4.0in D (41.30 cm x 26.36 cm x 10.16 cm) 12.22lbs (5.54kg)

45 Ohm

45 Ohm **V-ACS45**

Expands the V-ACS45 to 48 Zone **V-ACS-X48/45**

Expands the V-ACS45 to 72 Zone **V-ACS-X72/45**

16.15in W x 10.375in H x 4.0in D (41.30 cm x 26.36 cm x 10.16 cm) 12.22lbs (5.54kg)

Accessories:

24 Station Cable Adapter

for transition from V-2924 to V-ACS45 **V-CA2924**

All ACS Products VPU





Talkback Speakers & Accessories

A Round Ceiling Speakers

Industry recognized for exceptional performance for voice and music!

- White epoxy finish
 - Mounting hardware - See Page 5
- Colors: *White (Paintable), Custom Colors -CC*

8-Inch Round Ceiling Speaker Talkback **V-C806PK**
13.00in Dia x 2.25in D (33.02cm x 6.35cm) 2.50lbs (1.13kg)

8-Inch Round Ceiling Speaker Talkback **VC-1060A**
13.00in Dia x 2.25in D (33.02cm x 6.35cm) 2.50lbs (1.13kg)

B Square Ceiling or Wall Speaker

- White epoxy finish
- Colors: *White (Paintable), Custom Colors -CC*

8-Inch Square Ceiling Speaker Talkback **V-CTSQPK**
11.50in H x 11.50in W x 3.00in D (29.21cm x 29.21cm x 7.62cm) 2.60lbs (1.18kg)

C Lay-In Ceiling Speakers™ w/Backbox

Easy Lay-In installation replaces a 2' x 2' tile

- Lightweight - Weighs slightly more than a 2' x 2' ceiling tile!
- Save time, effort and money - Get on and off the job quickly
- No cutting tiles, no broken tiles, no mess
- Excellent music and voice quality
- Durable white acrylic baked enamel finish, *Custom Colors -CC*
- Integral backbox meets or exceeds ASTM E84 Flame & Smoke Test

Colors: *White (Paintable), Custom Colors -CC*

2' x 2' Lay-In Ceiling Speaker Talkback **VC-9062**
23.75in L x 23.75in W x 3.75in D (60.33cm x 60.33cm x 9.53cm) 8.3lbs (3.74kg)

2' x 2' Lay-In Ceiling Speaker Talkback (2 Pack) **V-CTLA-2**
23.75in L x 23.75in W x 3.75in D (60.33cm x 60.33cm x 9.53cm) 8.5lbs (3.83kg);
For 2 Pack: 14lbs (6.3kg)

Optional Trim Bar Use to Install in a 2 x 4 Ceiling Tile (10 Pack) **V-TBAR**
24.50in L x 1.25in W x 1.00in D (62.23cm x 2.54cm x 3.18cm) 3.50lbs (1.58kg)

D Metal Wall Speaker

- 8-Inch speaker, excellent voice and music quality
 - Easy installation, screw terminal connections
 - Black cloth grille, gray paintable metal housing
- Colors: *Gray (Paintable), Custom Colors -CC*

Metal Wall Speaker Talkback **V-WTGY**
10.13in H x 12.31in W x 4.63in D (25.73cm x 31.27cm x 11.75cm) 4.25lbs (1.91kg)

E Black or White Wall Speakers

- 8-Inch speaker, excellent voice and music quality
- Easy installation
- Black or white simulated woodgrain

Black Wall Speaker Talkback **VC-1061-BK**
White Wall Speaker Talkback **VC-1061-W**

9.60in H x 11.50in W x 4.00in D (24.38cm x 29.21cm x 10.16cm) 4.00lbs (1.81kg)

F Woodgrain Wall Speaker

- 8-Inch speaker, excellent voice and music quality
- Easy installation
- Light brown woodgrain, open-weave grille

Woodgrain Wall Speaker Talkback **VC-1062A**

9.60in H x 11.50in W x 4.00in D-Top, 3.75in D-Bottom
(27.31cm x 24.77cm x 12.70cm-T, 9.53cm-B) 4.50lbs (2.04kg)

G FlexHorn™ – Rugged Speaker

- Low ceilings such as light manufacturing or multi-floor warehouses
- Low to moderate noise environments
- Water-proof for environments requiring direct spray down such as car washes, food processing plants, and operating rooms
- Adjustable Mounting Bracket included (V-9804)
Mount on Wall, Ceiling or Beam

Colors: *Beige-BGE, Gray-GY, or White-W*

FlexHorn Talkback **VC-1090**
10.00in H x 12.25in W x 4.00in D (25.40cm x 31.12cm x 10.16cm) 8.35lbs (3.80kg)

Accessories (Not Pictured)

One-Way Paging Adapter **V-LPT**

Clock Control Interface Package **V-CLK**

Option Cards

Serial/Clock Driver Card **V-SER**

Clock Relay Card **V-CIO**

Backplane Cables

Cable - 4 Position Feature Cards **VC40R-4**

Cable/Terminator - 8 Position Feature Cards **VC40R-8T**

Cable/Terminator - 9 Position Feature Cards **VC40R-9T**

Cable/Terminator - 16 Position Feature Cards **VC40R-16T**

Call-In Switch

Emergency/Normal - Stainless Steel **V-2970**

Rocker Push Button - Stainless Steel (6 Pack) **V-2972PK**

Power Supply

6 Amp Positive 24 Vdc - Wall Mount **V-C6124P**



A

Vandal-Resistant SIP Intercom

This interior IP intercom can be easily installed in a variety of environments such as assisted living facilities, correctional facilities, business offices, school classrooms and more. Communicate with or without a SIP PBX.

- SIP compliant and Valcom Gateway accessible
- Peer-to-Peer capable
- PoE 802.3af enabled (Power-over-Ethernet)
- Fully network configurable
- Uses a standard electrical junction box enclosure
- High loudspeaker levels for use in moderate to high noise areas
- Paging speaker feature
- Mic and speaker volume control
- Stainless steel
- LED call status
- Multicast
- Enhanced tamper-resistance
- Optional: FXS or FXO access

- A **SIP Intercom Doorplate Speaker, Vandal-Resistant** **VIP-176A**
InformaCast[®] **VIP-176A-IC**
 4.88in H x 4.88in W x 2.50in D (12.40cm x 12.40cm x 6.40cm) 0.75lbs (0.34kg)
- B **Smart Relay** option
 for SIP Door Strikes
 & Gate Openers **VM-SRLY**



B

SIP Intercom with Long Line Extender (LLE)

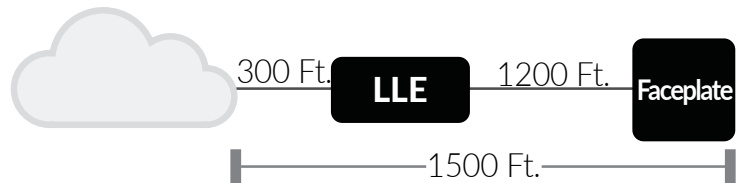

- Long line situations such as elevators, etc.
- Use with Cisco, Nortel, Avaya, and most modern IP telephone systems
- Automatic talkback VOX operation (No Push to Talk Button Needed)
- Companion to IP CCTV cameras
- SIP or Multicast communications
- AllCall 1000's of units with Valcom Gateway
- LED status indicator
- Indoor/Outdoor and tamper-resistant
- Compatible with secure networks
- Supervision with alert functions
- DHCP addressable
- High survivability - No server needed
- Built-in access control relay

- C **SIP Vandal-Resistant Stainless Steel**
Talkback w/LED **VIP-172AL-VRSS***
Talkback w/LED, InformaCast[®] **VIP-172AL-VRSS-IC***
Talkback w/LED, Syn-Apps[®] **VIP-172AL-VRSS-SA***
 4.50in H x 4.50in W x 1.75in D (11.43cm x 11.43cm x 4.45cm) 1.68lbs (0.76kg)
- D **Talkback w/LED Stainless Steel** **VIP-172AL-ST***
Talkback w/LED, InformaCast[®] **VIP-172AL-ST-IC***
 4.50in H x 4.50in W x 1.30in D (11.43cm x 11.43cm x 3.30cm) 0.50lbs (0.23kg)

* Long Line Extender

Long line extender for long distances



C



D

Analog Intercom Doorplate Speakers

- Indoor/outdoor
- Talkback speaker
- Call button
- Mounts in standard double gang electric box
- 11 gauge steel, *White paintable faceplate*
- 16 gauge steel, *Stainless Steel faceplate*

A **Vandal-Resistant Talkback White** **V-1073** 0
 4.50in H x 4.50in W x 1.75in D (11.43cm x 11.43cm x 4.45cm) 1.50lbs (0.63kg)

B **Talkback Stainless Steel** **V-1072A-ST** 0
Talkback with LED Stainless Steel **V-1072B-ST** 0
 4.50in H x 4.50in W x 1.30in D (11.43cm x 11.43cm x 3.30cm) 0.50lbs (0.23kg)

C **Surface Mount Talkback Gray, Plastic** **V-1074** 0
 5.50in H x 4.00in W x 1.13in D (13.97cm x 10.16cm x 2.87cm) 0.50lbs (0.23kg)

D **Accessory: Doorbox Weather Guard**
 for Intercom Doorplate Speakers (except C)
Black **V-9910-BK**
Yellow **V-9910-YEL**
 5.25in W X 5.38in H X 3.00in D (13.34cm X 13.67cm X 7.62cm) 1.25lbs (0.56kg)

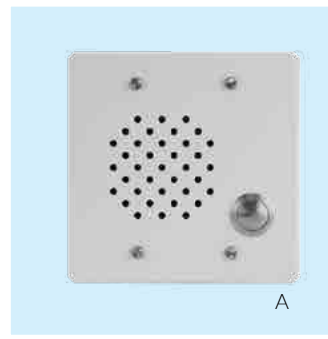

Push a button for two-way connection



Analog Door Answering/Unlock Devices

Answer & Door Unlock Capability

E **Single Door** **V-2901A** 12
 • Door unlock contact closure (strikeplate required)
 • Alarm functions
 • Transmit and receive volume controls
 • Background music input with volume control
 • Built-in ring generator with On/Off switch
 • 3 distinctive ring patterns
 • Programmable options include:
 - Door unlock codes
 - # of ring cycles before door request is terminated
 - Time the door remains unlocked
 • Requires -24 Vdc, 600 mA (filtered)
 8.60in H x 11.00in W x 2.30in D (21.84cm x 27.94cm x 5.84cm) 3.00lbs (1.36kg)

F **Four Door** **V-2904** 12
 All the functions of the single door plus:
 • Places simultaneous calls in queue
 8.60in H x 11.00in W x 2.30in D (21.84cm x 27.94cm x 5.84cm) 3.10lbs (1.41kg)

Answering Control Does Not Provide Door Unlock Capability

G **Single Door** **V-2900** 0
 • Ring generator
 • Built-in talkback amplifier
 • Transmit and receive volume control
 • Provides two-way communication
 • Power supply included (VP-324D)
 8.25in H x 4.50in W x 2.35in D (20.96cm x 11.43cm x 5.97cm) 3.10lbs (1.41kg)



Identify visitors and unlock doors

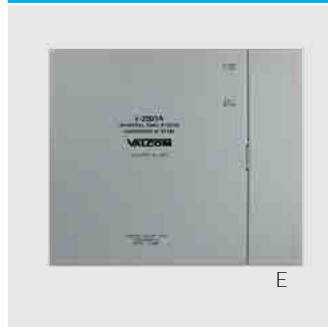

Call Buttons

Provides Remote Call-In Capability – Fits a single gang box

Use with IP Talkback Speakers, with Volume Control

- C **Emergency/Normal Stainless Steel** **VE2974**
- A **Normal Stainless Steel** **VE2973**

Use with IP Talkback Speakers, without Volume Control

- C **Emergency/Normal Stainless Steel** **VE2972**
- A **Normal Stainless Steel** **VE2975**

Analog, with Volume Control

- A **Normal Stainless Steel** **V-2971**
- 4.50in H x 2.75in W x 1.0in D (11.43cm x 6.99cm x 2.54cm) 0.20lbs (0.09kg)
- B **Normal White** **V-2991-W**
- 4.50in H x 2.75in W x 0.75in D (11.43cm x 6.99cm x 1.91cm) 0.20lbs (0.09kg)
- C **Emergency/Normal Stainless Steel** **V-2970**
- 4.50in H x 2.75in W x 1.00in D (11.43cm x 6.99cm x 2.54cm) 0.20lbs (0.09kg)
- D **Emergency/Normal White** **V-2995-W**
- 4.50in H x 2.75in W x 1.00in D (11.43cm x 6.99cm x 2.54cm) 0.20lbs (0.09kg)
- E **with Privacy Switch Stainless Steel** **V-9320**
- 4.50in H x 2.75in W x 1.00in D (11.43cm x 6.99cm x 2.54cm) 0.20lbs (0.09kg)
- F **with Braille Stainless Steel** **V-2977**
- 4.50in H x 2.75in W x 1.0in D (11.43cm x 6.99cm x 2.54cm) 0.20lbs (0.09kg)

Analog, without Volume Control

- G **Rocker Push Button Stainless Steel** **V-2972**
- 6 Pack:** 1.10lbs (0.50kg) **V-2972PK**
- 4.50in H x 2.75in W x 1.5in D (11.43cm x 6.99cm x 3.91cm) 0.20lbs (0.09kg)
- H **Emergency Vandal-Resistant, Red** **V-2976**
- 4.50in H x 2.75in W x 1.00in D (11.43cm x 6.98cm x 2.54cm) 0.25lbs (0.12kg)

I **4-Button Multi-function**

When used with other Valcom equipment, the buttons can be used to trigger events such as Lockdown, Call for Assistance, Code Blue, etc.

- 4-Button Multi-function** **VE2978**

J **4-Button Timer**

When connected to a compatible Valcom Speaker/Clock, the buttons will provide direct control of the timer functions available in the Speaker/Clock.

- Count Up/Down Timer Control** **VE2979**

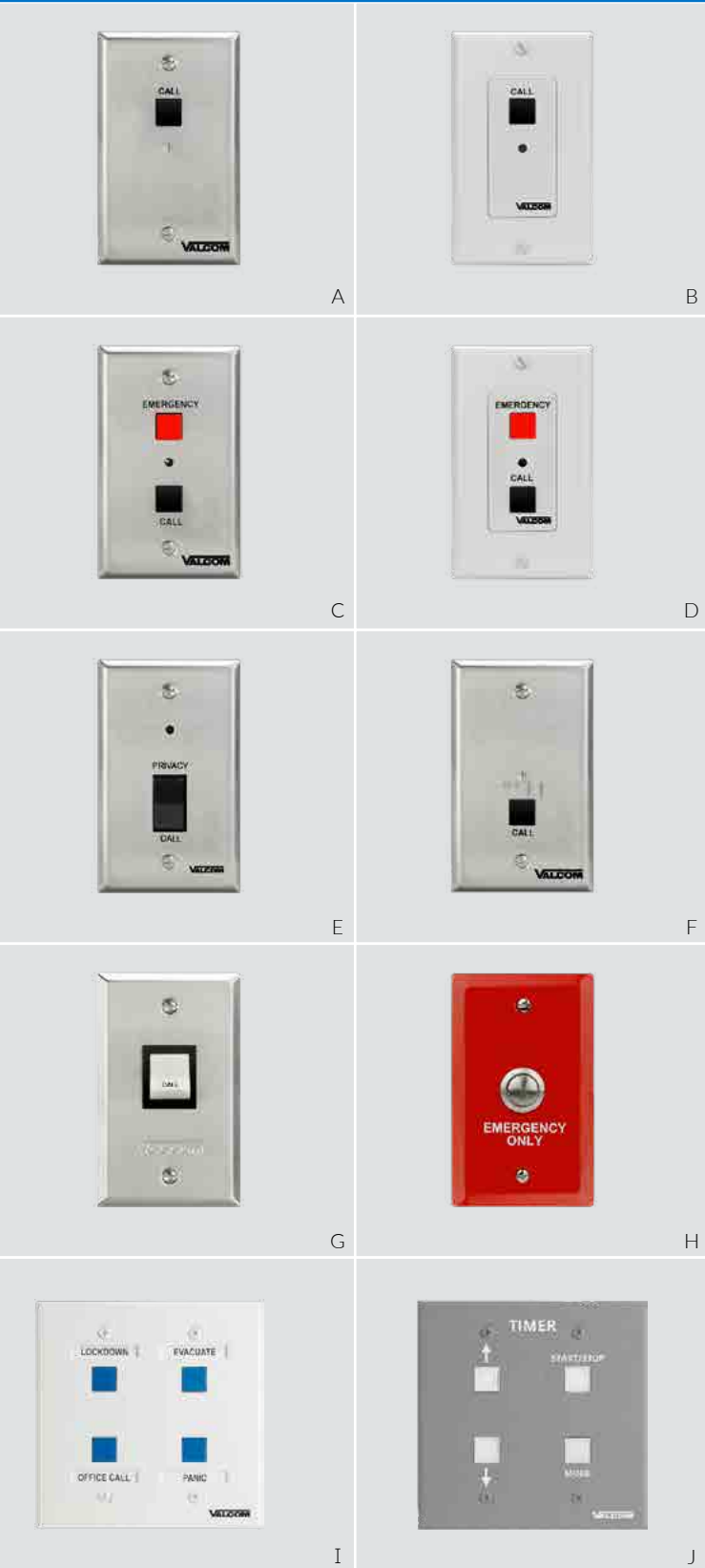

Accessory: 3RU Rack Mount

- Volume Control Panel Black** **V-VCPANEL-BK**
- Volume Control Panel Gray** **V-VCPANEL-GY**
- 5.22in H x 19.00in W x 1.00in D (13.62cm x 48.26cm x 2.54cm) 1.30lbs (.50kg)

Privacy Spot SoundMasking™ Speaker

Valcom's V-9422 Lay-In 2x2 Spot SoundMasking speaker allows you to create a curtain of audible noise that aids in masking conversations that can be easily overheard. Our Spot SoundMasking speaker is an inexpensive approach for healthcare facilities, government agencies, financial institutions, clergy, counselors, human resources and attorneys. The speaker is easily installed and works as both sound source and amplifier, so no additional equipment is necessary. The Spot SoundMasking speaker is separate from your overall communication system. The white noise sound coming from the speaker isn't interrupted when a page is made, and helps you remain compliant with the HIPPA in healthcare settings and uphold confidentiality in office settings.

- Constant 'white noise' (hissing sound)
- Built-in electronics and power supply included
- Easy installation - replaces a hallway ceiling tile
- Self-contained with built-in masking source and amplifier

Colors: White (Paintable), Custom Colors -CC

- A 2' x 2' Lay-In Spot SoundMasking Speaker V-9422 **NA****
 23.75in L x 23.75in W x 3.75in D (60.33cm x 60.33cm x 9.53cm) 5.50lbs (2.48kg)
 ASTM E84, CE

Measuring Sound Volume Control Sensors

When noise levels change, so do your speakers - automatically

- Constantly monitors the area and automatically adjusts the volume of the paging speakers
- Use one per zone and/or one per noise area
- Specifications: Output Impedance: 8 Ohm
Power Requirements: -24 Vdc, 100 mA

- B Noise Sensing Volume Control V-9933A **-2****
 7.30in H x 4.50in W x 2.00in D (18.54cm x 11.43cm x 5.08cm) 0.90lbs (0.41kg)

Remote Microphone (Must be used with V-9933A)

Measure your environments sound level

- Self-contained microphone and pre-amp
- No power supply required
- Up to 4 units may be paralleled on one V-9933A

- C Remote Microphone V-9934 **NA****
 1.50in H x 2.90in W x 0.81in D (3.81cm x 7.37cm x 2.06cm) 1.00oz (0.03kg)

Speaker Volume Controls

- Controls volume of up to 150 one-way speakers
- Stainless steel or white

- D Speaker Volume Control Stainless Steel V-1092 **0****
 4.50in H x 2.75in W x 2.00in D (11.43cm x 6.99cm x 5.08cm) 0.80lbs (0.36kg)

- E Speaker Volume Control without Single Gang Box
Stainless Steel V-1092B **0****
 4.50in H x 2.75in W x 1.00in D (11.43cm x 6.99cm x 2.54cm) 0.20lbs (0.09kg)

- F Speaker Volume Control White V-2992-W **0****
 4.50in H x 2.75in W x 2.00in D (11.43cm x 6.99cm x 5.08cm) 0.80lbs (0.45kg)

- G Speaker Volume Control-Slide Switch Stainless Steel V-1097 **0****
 4.50in H x 2.75in W x 1.25in D (11.43cm x 6.99cm x 3.18cm) 0.25lbs (0.11kg)
 ADA Compliant



Reduces possibility of conversations being overheard by hallway traffic.

Ideal for clergy, human resources, counselors, financial offices and attorneys

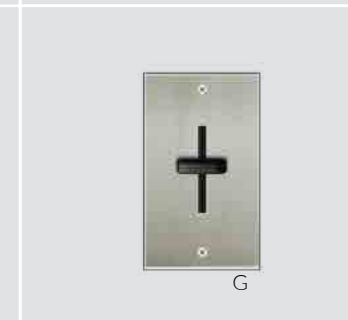
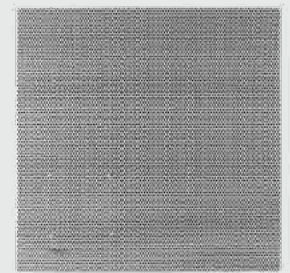



A



B



C



D



E

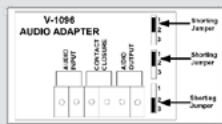

F

Microphones

Microphone Panel with Stored Messages

Record Up to 8 Stored Messages—Microphone for Live Announcements

- Stores and plays up to 8 recorded messages over paging system
- Provides 8 minutes of high quality digital recording
- Eight front panel buttons – for recorded message activation
- Push-to-Talk microphone for live announcements
- Power “ON” & visual system fault indicator
- Easy programming to upload/download voice messages
- Audio interface included (V-1096)

A **Stored Message/Mic Page Panel** **V-9908** ⑤
 4.25in H x 5.00in W x 2.00in D (10.80cm x 12.70cm x 5.08cm) 4.00lbs (1.50kg)

Dynamic Microphones

B **Desk Paging Microphone** **V-400** ①
 • Omni-directional pickup pattern
 • Push-to-Talk switch and locking bar
 • Lift-to-Talk switch with bypass slide switch provided
 9.40in H x 4.00in W x 6.00in D (23.90cm x 10.20cm x 15.24cm) 1.40lbs (0.64kg)

C **Handheld Noise Canceling Microphone** **V-420** ①
 • Handheld with Press-to-Talk lever
 • Heavy duty coil cord extends to 6 feet
 3.94in H x 2.97in W x 2.63in D (10.00cm x 7.54cm x 6.68cm) 0.63lbs (0.29kg)

D **Omni-Directional Gooseneck Microphone** **V-450** ①
 • Omni-directional pickup pattern
 • Push-to-Talk switch
 Microphone: 1.75in Dia x 4.63in L (4.44cm x 11.75cm),
 Gooseneck 19in L (48.26cm) 1.03lbs (0.59kg)

Ideal for restaurants, retail stores, bowling alleys, offices, transportation terminals and dispatch centers where a microphone is needed

Accessories:

E **Microphone Adapter** **V-9939C** ①
 • Provides contact closure
 8.25in H x 4.50in W x 2.35in D (20.95cm x 11.43cm x 5.97cm) 0.70lbs (0.32kg)

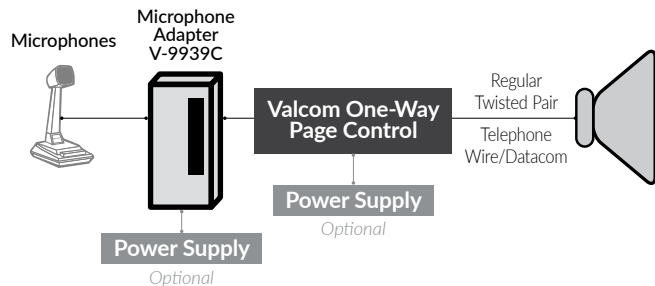

F **Audio Interface** **V-1096** ①
 1.75in H x 3.75in W x 1.25in D (4.45cm x 9.53cm x 3.20cm) 0.50lbs (0.23kg)

Screw Terminal Block **VM-150**
 For connecting heavy gauge speaker wire to Amphenol terminated intercom circuit cards



E

Paging Expansion

A Input Line Matching Transformer VMT-1 **NA**

- Functions as output-matching transformer to feed program material Over a 600 Ohm telephone line for “music-on-hold”
- Hi-Z, 10k Ohm primary impedance
- Lo-Z, 600 Ohm secondary impedance, balanced with center tap
- Matches high-to-low impedance or low-to-high impedance
- Adapts line level signals to microphone inputs

1.75in H x 3.75in W x 1.25in D (4.45cm x 9.53cm x 3.18cm) 0.50lbs (0.23kg)

B Audio Isolation Transformer VMT-2 **NA**

- Magnetically coupling line level audio
- Isolating ground references from one audio circuit to another

1.75in H x 3.75in W x 1.25in D (4.45cm x 9.53cm x 3.18cm) 0.50lbs (0.23kg)

C Expand 25/70/100 V systems without straining the existing amplifier

70 V Expander *Stainless Steel* V-1095 **0**

- Connects to amplifier output or anywhere on 25/70/100 V line
- No costly amplifiers or heavy gauge cable required
- Specifications: Output Impedance: 8 Ohm
- Single gang box

4.44in H x 2.75in W x 2.88in D (11.28cm x 6.99cm x 7.32cm) 0.90lbs (0.41kg)

Unlimited expansion is a breeze with Valcom amplified speakers

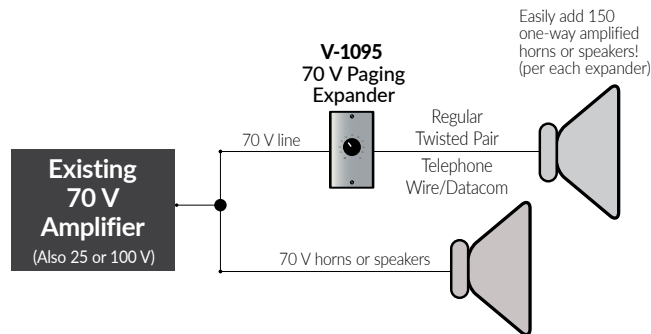

PreAmp Expanders

Add speakers on and on and on ...

- Pre-amplifies low level audio to remote sites
- Virtually unlimited expansion (150 one-way speakers per box)
- Master volume control for entire system/groups of remote speakers
- Isolates page port from speaker lines
- Specifications: Output Impedance: 8 Ohm
- Power Requirements: -24 Vdc, 45 mA
- Single Gang Box

D Page Port PreAmp/Expander *Stainless Steel* V-1094A **-1**

4.44in H x 2.75in W x 2.88in D (11.28cm x 6.99cm x 7.32cm) 0.80lbs (0.38kg)

E Page Port PreAmp/Expander w/o Single Gang Box SS. V-1094B **-1**

4.44in H x 2.75in W x 0.75in D (11.43cm x 6.99cm x 1.91cm) 0.20lbs (0.09kg)

F Page Port PreAmp/Expander *White* V-2994-W **-1**

4.50in H x 2.50in W x 2.00in D (11.28cm x 6.99cm x 5.08cm) 0.80lbs (0.36kg)



A



B



C

Connects system to most public address amps for phone paging



D



E

PreAmp Expanders

Add speakers on and on and on ...



F



2-Channel Mixer
Expandable to 10 Channels
- with Remote



4-Channel Mixer



Remote Module

Complete sound system for

- Conference Rooms
- Meeting Rooms
- Lecture Halls
- Sporting Complexes
- Restaurants
- Institutional Cafeterias
- Auditoriums
- Gymnasiums



B



D



E



F



G

Managing Sound In-Wall Modular Mixer

Channel Mixers (Common Features: V-9983-W & V-9985-W)

- Built-in compressor (Option Switch Controlled) for automatic consistent volume level adjustment even when voices vary - low to high
- Master volume control for optimum adjustments and for each input
- 1 general building page input (-10dBm) overrides all others
- Drives 50 amplified speakers/horns
- 8 segment LED meter for visual indication of audio signal levels
- Full frequency range output for speakers
- High pass output horn filter

Remote Module

- 1 balanced XLR mic input & 1 aux input for MP3 players, CD, DVD or PC's
- Connects to main control module, with 2 pair 24 Awg cable
- Volume control for each input
- Phantom power (switch controlled w/"ON" indicator) allows use of consumer mic

- A **2 Channel In-Wall Mixer White** **V-9983-W** ①
4.25in H x 5.00in W x 2.00in D (10.80cm x 12.70cm x 5.08cm) 0.40lbs (0.18kg)
- B **4 Channel In-Wall Mixer White** **V-9985-W** ①
4.25in H x 6.75in W x 2.00in D (10.80cm x 17.15cm x 5.08cm) 0.65lbs (0.29kg)
- C **In-Wall Remote Module White** **V-9984-W** ①
4.25in H x 1.64in W x 2.00in D (10.80cm x 4.17cm x 5.08cm) 0.25lbs (0.11kg)

- D **120-Watt Amplifier** **SM120**
Audio power for voice paging or background music systems.
17.00in W x 12.00in D x 1.75in H (43.23cm x 30.50cm x 4.40cm) 5.10lbs (2.30kg)

- E **Remote Volume Control** **SM-VC**
The SM-VC allows adjusting the output level of the SM120 Amplifier from a remote location. The SM-VC fits into a standard single-gang electrical box.
4.50in H x 2.80in W x 1.50in D (11.40cm x 7.11cm x 3.81cm) 0.20lbs (0.09kg)

- F **Remote Input Module** White **V-9130-W**
Provides passive stereo to mono for line level audio sources and features both RCA and 3.5mm stereo headphone jack connection options.
4.13in H x 1.63in W x 1.13in D (10.49cm x 4.14cm x 2.87cm) 1.00lbs (0.45kg)

- G **6 Channel Amplifier (70 Volt)** **V-6120** ①
• 6 independent channels of amplification
• Four 10-Watt outputs/two 40-Watt outputs
• Quick release screw terminals
• Activity LED indicators
• High pass horn filter on 40-Watt outputs
• Independent volume controls for each channel
• Power indicator
• Transformer coupled inputs
• 115 - 250 Vac
3.50in H x 17.00in W x 15.00in D (8.89cm x 43.18cm x 38.10cm) 21.00lbs (9.53kg)

Eliminate Feedback Digital Stacking Feedback Eliminator

Eliminate busy signals on heavily used paging systems/prevents acoustic feedback

- Multiple messages recorded simultaneously
- Stacks messages - records a page while playing one
- One unit eliminates feedback to ALL zones
- Automatic consistent volume level even when recording voices vary - low to high
- High-fidelity - voice sounds natural not like a recording
- LED Indicators for play, record, busy, power
- Dipswitch features: pre-announce alert tone, priority override (Real time or delayed), DTMF message cancel
- Real time background music input with volume control
- Two audio outputs: 8 and 600 Ohms
- Emergency messages can interrupt play back sequence
- Power requirements: -24 Vdc, 250 mA
- Multiple units can be stacked for additional inputs
- Can provide provide feedback elimination on one zone or all zones when connected in front of a multizone page control

A Stacking Feedback Eliminator V-9964 ④

11.76in H x 7.10in W x 1.72in D (29.87cm x 18.03cm x 4.37cm) 2.60lbs (1.18kg)

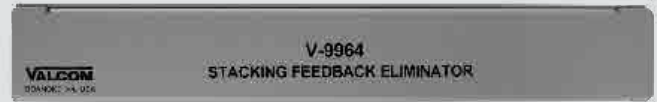

A

Tired of having a squeal over paging speakers when you page?



Background Music Message-On-Hold USB Devices

A solid-state digital message repeater installs easily into any messaging application that requires triggered, continuous or timed message play

- Messages and MP3 files are stored on 16MB - 4GB USB flash drives
- Playback quality up to 128 Kbps
- Built-in monitor speaker
- LED status indicator
- Store up to 99 messages
- Triggered and/or timed playback
- Active output indication trigger
- Auxiliary 12 Vdc output for wiring sensors
- Power supply included

B USB Multi-Messenger Device V-9989 ④

5.10in H x 6.30in W x 1.75in D (12.95cm x 16.00cm x 4.45 cm) 2.40lbs (1.08kg)

C USB Message-On-Hold Device V-9988 ④

5.10in H x 6.03in W x 1.75in D (12.95cm x 15.32cm x 4.45cm) 2.10lbs (1.04kg)



B



C

Sell your products and services while you have your customers on-hold!





A



B



C



D



E

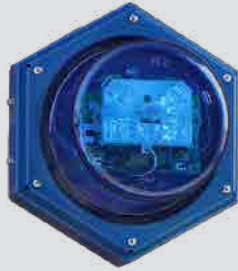

F



G



H



I



J

Audible Alerting – Tones

Loud Ringer Horns

- 90 Vac ring or 18 Vac buzzer voltage activation
- Connects directly to PBX station port
- Built-in tone generator, 5-Watt amplifier and volume control

A **Loud Warble Ringer Horn** **V-9925A**

6.50in H x 8.20in W x 10.40in D (16.51cm x 20.83cm x 26.42cm) 3.60lbs (1.63kg)

B **Single Tone Warble Horn** Power Supply Included. **V-9945A**

6.50in H x 8.20in W x 10.40in D (16.51cm x 20.83cm x 26.42cm) 4.30lbs (1.95kg) FCC Part 15

Add Tones Over Paging

Up to 8 different tones with a single unit: choice of 2 sets of 8 different tones

- Siren Evacuation*
- Steady Shift Changes*
- Chime Doorbutton/Code Call
- Whoop Tornado*
- Burst Alarm Signal*
- Dual Chime Doorbell Ring
- Warble Fire*
- TeleBell Auxiliary Ring
- *USA Standard Immediate Evacuation Signals

C **Multi-Tone Generator** **V-9927A**

8.20in W x 4.55in H x 2.30in D (20.83cm x 11.56cm x 5.84cm) 1.40lbs (0.68kg)

D **C.O. Line Audible Ring Unit – 6 Lines** **V-9936A**

- 90 Vac ring or dry contact closure activation
- Connects directly up to 6 C.O. or PBX station lines
- Contact closure output to activate loud bells
- Automatically overrides page or music
- Built-in warble tone generator

8.20in H x 4.55in W x 2.30in D (20.83cm x 11.56cm x 5.84cm) 1.50lbs (0.68kg)

E **C.O. Line Audible Ring Unit – 1 Line** **V-9924C**

- 90 Vac, 18 Vac, or dry contact closure activation
- Connects to analog PBX station port
- Provides 3 separate zone outputs and volume controls
- Automatically overrides page or music

8.20in H x 4.55in W x 2.30in D (20.83cm x 11.56cm x 5.84cm) 1.30lbs (0.59kg)

Visual Alerting – Strobes

Flash of light to get attention in noisy areas where paging can't be heard

F **IP Strobe, Indoor/Outdoor** Blue **VIP-997-BL**

InformaCast® **VIP-997-BL-IC**

Syn-Apps® **VIP-997-BL-SA**

Larger size is an ideal fit for gymnasiums or manufacturing plants

- Night ring functionality in conjunction with other Valcom IP speakers
- Synchronized strobing when used with additional Valcom IP strobes

9.00in H x 7.80in W x 5.5in D (22.86cm x 19.80cm x 13.97cm) 3.30lbs (1.50kg)

G **IP Strobe** Amber -AM, Blue -BL, White -WH **VIP-998**

InformaCast® **VIP-998-IC**

Syn-Apps® **VIP-998-SA**

- Can activate multiple strobes via single SIP call

- Activate on group audio
- PoE, 15,30,75,95,110 Candela

5.50in H x 5.00in W x 2.00in D (13.90cm x 12.70cm x 5.08cm) 0.62lbs (0.27kg)

H **Strobe** **V-5580041C**

110 candela of brilliancy strobe, covers 70 ft by 70 ft area – ADA Compliant

- Power supply included
- Mount strobe 80 inches above floor
- Activated by applying power, dry contact closure, 70 V speaker voltage

CAUTION: DO NOT USE 2 STROBES WITHIN SAME FIELD OF VIEW

5.63in H x 4.63in W x 4.50in D (14.29cm x 11.75cm x 11.43cm) 1.40lbs (0.64kg)

I **Threat Level Indicator** **VIP-996**

- Both power/activation provided by the IP network

- Bright LEDs in three colors: Red, Yellow, Green

4.55in H x 4.55in W x 1.50in D (11.55cm x 11.55cm x 3.81cm) 0.45lbs (0.20kg)

J **Auxiliary Relay Unit** **V-9955**

for Strobe Activation, Door Control, Camera Control

- Three 24 Vdc 2 pole relays with 1 Amp contacts

- Independent control or simultaneous operation of relays

11.76in H x 7.10in W x 1.72in D (29.87cm x 18.03cm x 4.37cm) 2.60lbs (1.18kg)

Lights and Sounds for different situations

LED Visual Message Signs

Utilized for broadcasting visual and voice message alerts including daily or emergency alerts

- RJ45 for network connection • Network activity LEDs
- IP set up for configuration • Supervised/monitoring
- Static or DHCP configurable
- Visual message maybe programmed for one or two lines with options for color, transitions and fonts

20-Inch Wide

- A **IP Speaker-with-Text and Flashers, Black** **VL520BK-F**
InformaCast® **VL520BK-F-IC**
Syn-Apps® **VL520BK-F-SA**

- B **IP Speaker-with-Text and Flashers, Metallic** **VL520M-F**
InformaCast® **VL520M-F-IC**
Syn-Apps® **VL520M-F-SA**

20.38in W x 5.50in H x 2.50in D (51.80cm x 14.00cm x 6.40cm) 4.65lbs (2.10kg)

20-Inch Wide, Double-Sided

- C **IP Speaker-with-Text and Flashers, Black** **VL522BK-F**
InformaCast® **VL522BK-F-IC**
Syn-Apps® **VL522BK-F-SA**

- D **IP Speaker-with-Text and Flashers, Metallic** **VL522M-F**
InformaCast® **VL522M-F-IC**
Syn-Apps® **VL522M-F-SA**

22.50in L x 5.40in W (top)/ 3.80in W (bottom) x 5.55in H
 (57.20cm x 13.70cm (top)/ 9.70cm (bottom) x 14.10cm) 7.00lbs (3.10kg)
 Mounting Bracket: 7.25in W x 8.00in H x 1.40in D (18.40cm x 20.30cm x 3.60cm)

40-Inch Wide

- E **IP Speaker-with-Text and Flashers, Black** **VL550BK-F**
InformaCast® **VL550BK-F-IC**
Syn-Apps® **VL550KB-F-SA**

- F **IP Speaker-with-Text and Flashers, Metallic** **VL550M-F**
InformaCast® **VL550M-F-IC**
Syn-Apps® **VL550M-F-SA**

41.75in L x 5.88in H x 3.00in D (Top), 2.50in D (Bottom)
 (106.00cm x 14.90cm x 7.60cm (top) x 6.40cm (Bottom))

Accessories:

- G **Wire Guard for VL-520 (2 Pack)** **V-WGVL520-2**
 22.90in L x 7.20in H x 4.00in D (58.20cm x 18.30cm x 10.20cm) 2.50lbs (1.13kg)

- H **Wire Guard for VL-550 (2 Pack)** **V-WGVL550-2**
 44.50in W x 7.20in H x 4.00in D (113.00cm x 18.30cm x 10.20cm) 4.40lbs (2.00kg)

I Threat Level Indicator Add-On

Ideal for a variety of scenarios where visible alerting by colors are needed. International color indicators of red at top, yellow in the middle and green on the bottom, benefit color blind individuals in emergency conditions.



- Threat Level Indicator, Add-On** **VL-TL3**

Does not work with the InformaCast® and Syn-Apps® Versions
 5.50in H x 1.75in W x 0.50in D (13.97cm x 4.44cm x 1.27cm) 0.13lbs (.06kg)

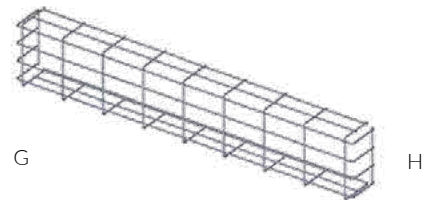
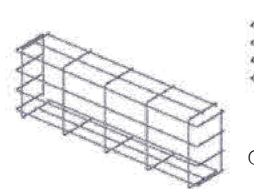

A single button press, gives those in need a two-way connection with security personnel.

A Vandal-Resistant IP Emergency Call Tower

Mass notification broadcast for parking lots, athletic fields and pathways

Unique, Contemporary Style

- Full SIP functionality – multi SIP servers
- Rugged, low power
- Compatible with Cisco, Avaya and most modern IP telephone systems
- Call button calls a SIP address or any Valcom Gateway device
- Provides enhanced caller ID
- Automatic talkback operation (no push-to-talk button required)
- SIP or Multicast addressable
- Messaging broadcast capability
- High intensity LED blue flashing light
- LED lighted call button
- Supervision with alert functions
- Vandal and tamper-resistant
- Lightweight – only 75 pounds!

Options:

- Fiber
- PoE
- 115 – 240 V
- Camera
- WiFi
- Colors and Markings
- 1 or 2 Buttons



IP PoE Emergency Call Tower **VE9811**

InformaCast® **VE9811-IC**

Approximately 114.00in H x 10in Dia (289.56cm x 25.40cm) 75.00lbs (32.70kg)



Call for configuration assistance and pricing.

SIP Vandal-Resistant Emergency Call Station

Provides high visible security for hallways, transit centers, building/dorm entrance and parking decks

- Easy, RJ-45 Plug-in, CAT 5 or 6
- Call button calls a SIP address or any Valcom Gateway device
- SIP or Multicast addressable
- Red LED status indicator
- Network programmable for control and setup
- Automatic talkback VOX operation (no push-to-talk button needed)
- Compatible with most modern IP telephone systems
- Blue flashing light

B Emergency Call Station **VIP-9895**
InformaCast® **VIP-9895-IC**
 32.15in H x 9.90in W x 8.00in D (81.66cm x 25.10cm x 20.30cm) 39.75lbs (18.10kg)

SIP Multi-Button Emergency/ Information Call Station

- 1, 2, 3 or 4 call programmable call buttons
 - emergency, general, directions, recorded information
- Emergency calls take precedence over all other calls
- Convenient "Voice Operated Switch" VOX operation
- Flush, surface mount

C Multi-Button Call Station **VIP-9894**
InformaCast® **VIP-9894-IC**
 14.62in H x 9.87in W x 5.07in D (37.20cm x 25.10cm x 12.90cm) 5.00lbs (2.30kg)

SIP Vandal-Resistant Emergency Call Station

- Loud horn for large areas
- Door relay connection
- Surface mount steel enclosure
- Stainless steel faceplate

D IP Call Station **VIP-9890A-EM**
InformaCast® **VIP-9890A-EM-IC**
IP Call Station Long Line Extender **VIP-9890AL-EM**
InformaCast® Long Line Extender **VIP-9890AL-EM-IC**
 10.00in H x 12.50in W x 4.00in D (25.40cm x 31.75cm x 10.20cm) 10.75lbs (4.89kg)

SIP Vandal-Resistant Call Station

- Door relay connection
- Surface mount steel enclosure
- Stainless steel faceplate

E IP Intercom/Doorphones Long Line Extender **VIP-9890AL-CB**
InformaCast® Long Line Extender **VIP-9890AL-CB-IC**
 10.00in H x 12.50in W x 4.00in D (25.40cm x 31.75cm x 10.20cm) 10.75lbs (4.89kg)

IP Repurpose Emergency Call Plate

Allows retrofit of existing analog emergency telephone enclosures to provide advanced IP features such as page broadcasts, all call and monitoring (Ex; Code Blue, Talk-A-Phone, Gai-tronics)

F IP Repurpose Emergency Call Plate **VE9870A**

See website for dimensions and weights.

Exterior Wall or Pole Mount



B



C



D



E

Retrofit to provide Advanced IP features



F



B



Colors

Available in: Red, Blue, Yellow and Gray.

Call for configuration assistance & pricing.



A



B



C



D



E



F



G



H



I



J



K



L

IP PoE Clocks

Analog

- A **12-Inch** **VIP-A12A**
12.81in Dia x 1.20in D (32.54cm x 3.05cm) 3.70lbs (1.68kg)
- B **16-Inch** **VIP-A16A**
16.81in Dia x 1.60in D (42.70cm x 4.06cm) 5.35lbs (2.43kg)
- Double-Sided**
- C **12-Inch** **VIP-A12ADS**
12.81in Dia x 7.00in D (32.54cm x 17.78cm) 11.00lbs (4.99kg)
- D **16-Inch** **VIP-A16ADS**
16.81in Dia x 7.25in D (42.70m x 18.42cm) 12.60lbs (5.72kg)

Digital

4-Digit **HH:MM**

- E **2.5-Inch Numbers** **VIP-D425A**
10.65in L x 3.00in W x 4.90in H (27.05cm x 7.62cm x 12.45cm) 2.88lbs (1.31kg)
- F **4.0-Inch Numbers** **VIP-D440A**
17.00in L x 3.00in W x 6.75in H (43.18cm x 7.62cm x 17.14cm) 5.10lbs (2.31kg)

4-Digit Double-Sided

- G **2.5-Inch Numbers** **VIP-D425ADS**
11.50in L x 4.25in W x 5.50in H (29.21cm x 10.80cm x 13.97cm) 5.90lbs (2.68kg)
- H **4.0-Inch Numbers** **VIP-D440ADS**
17.38in L x 4.25in W x 6.85in H (44.15cm x 10.80cm x 17.40cm) 9.10lbs (4.14kg)

6-Digit **HH:MM:SS**

- I **2.5-Inch Numbers** **VIP-D625A**
15.30in L x 3.00in W x 4.90in H (38.86cm x 7.62cm x 12.45cm) 3.85lbs (1.75kg)
- J **4.0-Inch Numbers** **VIP-D640A**
24.75in L x 3.00in W x 6.75in H (62.87cm x 7.62cm x 17.15cm) 7.07lbs (3.21kg)

6-Digit Double-Sided

- K **2.5-Inch Numbers** **VIP-D625ADS**
16.12in L x 4.25in W x 5.50in H (40.94cm x 10.80cm x 13.97cm) 7.30lbs (3.10kg)
- L **4.0-Inch Numbers** **VIP-D640ADS**
25.25in L x 4.25in W x 6.85in H (64.14cm x 10.80cm x 17.40cm) 12.20lbs (5.45kg)

Accessories:

Double-sided comes with mounting bracket/hardware for either wall or ceilings.
(To attach to ceiling tile use V-9914M-5 Bridge - See page 5.)

Wireless Clocks

Analog

- A **12-Inch, Battery Operated** **V-AW12B**
- B **12-Inch, Military Dial** **V-AW12B-MD**
- C **12-Inch, 110 Vac/24 Vdc** **V-AW12BLP**
12.65in Dia x 2.18in D (32.13cm x 5.54cm) 2.50lbs (1.13kg)
- D **16-Inch, Battery Operated** **V-AW16B**
- E **16-Inch, 110 Vac/24 Vdc** **V-AW16BLP**
16.65in Dia x 2.18in D (42.29cm x 5.54cm) 4.00lbs (1.81kg)

Digital

4-Digit **HH:MM**

- F **2.5-Inch Numbers, 110 Vac** **V-DW11025B**
7.50in H x 11.38in W x 4.25in D (19.05cm x 28.91cm x 10.80cm) 2.00lbs (0.91kg)
- G **4.0-Inch Numbers, 110 Vac** **V-DW11040B**
9.75in H x 14.25in W x 4.25in D (24.77cm x 36.20cm x 10.80cm) 3.50lbs (1.59kg)

Wired Clocks

Analog

- H **12-Inch, 24 Vdc** **V-A2412B**
- H **12-Inch, 110 Vac** **V-A11012B**
12.81in Dia x 1.50in D (32.54cm x 3.81cm) 4.00lbs (1.81kg)
- I **16-Inch, 24 Vdc** **V-A2416B**
- I **16-Inch, 110 Vac** **V-A11016B**
16.81in Dia x 1.60in D (42.70cm x 4.06cm) 6.00lbs (2.72kg)

Digital

4-Digit **HH:MM**

- J **2.5-Inch Numbers, 24 Vdc** **V-D2425B**
4.69in H x 10.31in W x 3.90in D (11.91cm x 26.19cm x 9.91cm) 1.30lbs (0.59kg)
- K **4.0-Inch Numbers, 24 Vdc** **V-D2440B**
6.75in H x 13.31in W x 6.75in D (17.15cm x 33.81cm x 9.80cm) 3.50lbs (1.59kg)

See website for dimensions and weights.



A & C



B



D & E



F



G



H



I



J



K



Proven
Time-Keeping
Accuracy and
Reliability

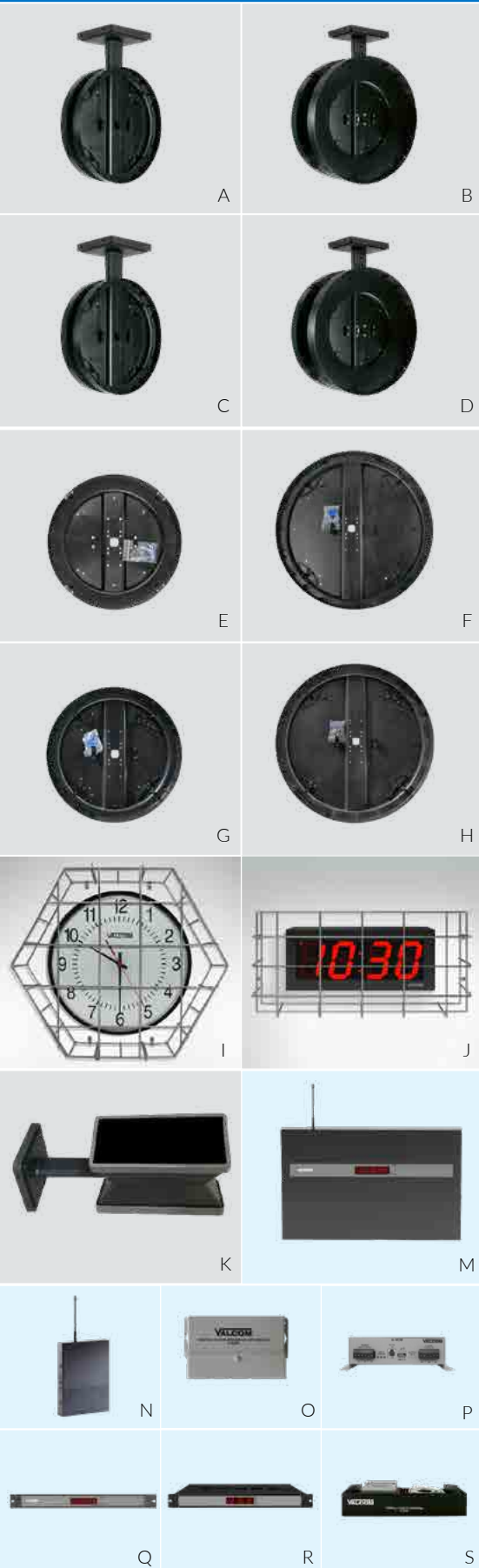

See website for dimensions and weights.

Analog Accessories

Double-Sided Brackets for Wireless Clocks

- A 12-Inch Analog Clocks [V-WDM-12](#)
- B 16-Inch Analog Clocks [V-WDM-16](#)

Double-Sided Brackets for Wired Clocks

- C 12-Inch Analog Clocks [V-BDM12-S](#)
- D 16-Inch Analog Clocks [V-BDM16-S](#)

Surface Mounting for Wired Clocks

- E 12-Inch Clocks [V-SMR12A](#)
- F 16-Inch Clocks [V-SMR16A](#)

Surface Mounting for Wireless Clocks

- G 12-Inch Clocks [V-SMR12AW](#)
- H 16-Inch Clocks [V-SMR16AW](#)

- I Wire Guards
for 12 and 16-Inch Analog Clocks [V-WGACLK](#)

Digital Accessories

- J Wire Guards
for 4-Digit Digital Clocks [V-WGD4](#)

- K Double-Sided Brackets
for 4-Digit Digital Clocks [V-DMKIT](#)

Clock Controls & Drivers



- L IP Master Clock [VIP-MC](#)
Features built-in correction relays and the protocols to correct most industry standard clocks. It also features BCD and Valcom 2-wire digital correction protocols. Setup is easy via the front panel LCD display, a built-in web GUI or the Valcom VIP-102B IP Solutions Setup Tool

- M Wireless Master Clock Transceiver [V-WMCA](#)

- N Wireless Repeater [V-WMCRA](#)
Must be used with a V-DCPI Digital Clock Protocol Interface, a V-GPSA GPS Receiver, V-WMCA Wireless Master Clock or a VIP-MC

- O Digital Clock Protocol Interface [V-DCPI](#)

- P Clock Interface Controller Kit [V-VCU](#)

- Q GPS Master Clock Wireless [V-GPS-TX](#)

- R GPS Master Clock Wired [V-GPSA](#)
Using Valcom Wired Clock (2-wire correction), Add 6 Amp 2-Wire Clock Driver (V-VCU)

- S Digital Clock Head End Driver, 2-Wire [V-DCH](#)

- Not Pictured Clock Controller [V-CCU](#)

Analog – Flush Mount Colors: White, Custom Colors -CC

- A **One-Way or Talkback Programmable** [VIP-429A-A](#)
Talkback, InformaCast® [VIP-429A-A-IC](#)
Talkback, Syn-Apps® [VIP-429A-A-SA](#)
14.50in H x 13.00in W x 3.40in D (36.93cm x 33.02cm x 8.64cm) 4.80lbs (2.18kg)
- B **Talkback, InformaCast®** [VIP-431A-A-IC](#)
20.28in H x 14.38in W x 4.50in D (51.51cm x 36.53cm x 11.43cm) 4.25lbs (1.91kg)



A



B

Digital – Flush Mount Colors: White, Custom Colors -CC

- C **6-Digit HH:MM:SS**
One-Way or Talkback Programmable [VIP-426A-D](#)
- D **4-Digit HH:MM**
One-Way or Talkback Programmable [VIP-429A-D](#)
Talkback, InformaCast® [VIP-429A-D-IC](#)
Talkback, Syn-Apps® [VIP-429A-D-SA](#)
14.50in H x 13.00in W x 3.40in D (36.93cm x 33.02cm x 8.64cm) 4.80lbs (2.18kg)

Backboxes for A, C, D

Angled Mount [VB-A24](#)
14.48in H x 13.13in W x 5.00in D1 x 2.97in D2
 (36.78cm x 33.35cm x 12.70cm)

Recessed Mount [VB-R22](#)
13.25in H x 11.25in W x 3.75in D (33.66cm x 28.58cm x 9.53cm)

Surface Mount [VB-S23](#)
14.63in H x 13.13in W x 3.94in D (37.16cm x 33.35cm x 10.01cm)



C



D



E



F

Digital – Flush Mount Colors: Gray, Custom Colors -CC

- E **4-Digit HH:MM**
One-Way or Talkback Programmable Gray [VIP-432A-DF](#)
One-Way, InformaCast® Gray [VIP-432A-DF-IC](#)
20.28in H x 14.38in W x 3.40in D (51.51cm x 36.53cm x 8.64cm) 4.25lbs (1.91kg)

Backboxes for B & E

Angled Mount [VB-A21](#)
19.88in H x 14.27in W x 6.27in D1 x 2.72in D2
 (50.50cm x 36.25cm x 15.93cm D1 x 6.91cm D2)

Recessed Mount [VB-R19](#)
19.25in H x 10.75in W x 3.75in D (48.90cm x 27.31cm x 9.23cm)

Surface Mount [VB-S20](#)
20.18in H x 14.27in W x 2.78in D (51.26cm x 36.25 x 7.06cm)



D

Angled Surface Mount - Digital Colors: Gray, Custom Colors -CC (No Backbox Required)

- F **4-Digit HH:MM**
One-Way or Talkback Programmable [VIP-431A-DS](#)
One-Way, InformaCast® [VIP-411A-DS-IC](#)
Talkback, InformaCast® [VIP-431A-DS-IC](#)
Talkback, Syn-Apps® [VIP-431A-DS-SA](#)
14.90in H x 12.40in W x 4.80in D1 (top, with grille) 1.40in D2 (bottom)
 (37.80cm x 31.50cm x 12.20cm (D1) 3.60cm (D2) 4.25lbs (1.90kg)



One Network Connection A Convenient IP Speaker Clock Kit for Classrooms

- Provides synchronized time, talkback and loudspeaker paging capabilities
- Clock synchronizes using Network Time Protocol (NTP)
- IP Speaker Clock Kit acts as a single endpoint
- Requires only one network port connection
- Power over Ethernet provides power to both the clock and speaker
- 50ft of pre-terminated cable included for speaker-to-clock-connection
- Optional Call Buttons available for emergency call and/or lockdown confirmation [page 32]

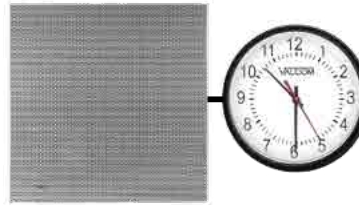

2x2 Lay-In Ceiling Speaker with Analog Clock
VIP-4122-A12-IC

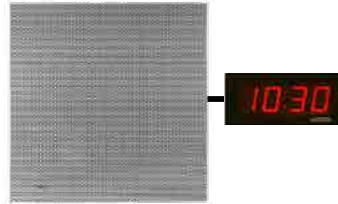

2x2 Lay-In Ceiling Speaker with Digital Clock
VIP-4122-D44-IC



Wall Speaker with Analog Clock
VIP-4171-A12-IC



Wall Speaker with Digital Clock
VIP-4171-D44-IC

Single Port Device™

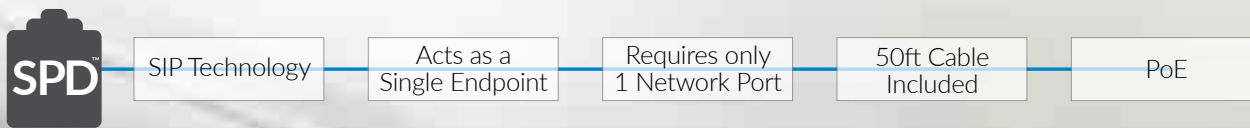

**Synchronized time, talkback
and loudspeaker paging capabilities**

50ft Cable
Included



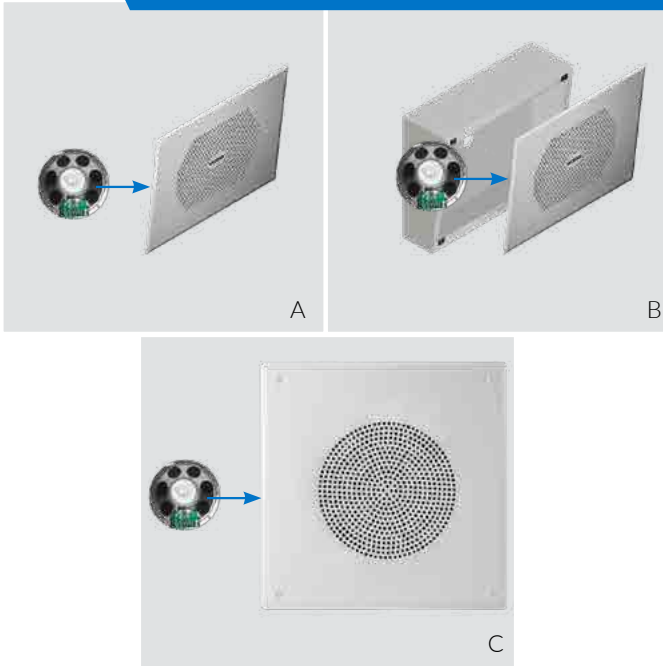



Speaker Assemblies

Choose Faceplate

- A **Vandal-Resistant Faceplate Recessed Mount** **V-9808**
 - Heavy Gauge Steel Construction (Indoor)
 - Colors: Gray (Paintable), Custom Colors -CC
 - 10.00in H x 12.25in W x 16 GA (25.40cm x 31.12cm x 16 GA) 2.40lbs (1.10kg)
- B **Vandal-Resistant Faceplate & Enclosure Surface Mount** **V-9807**
 - Heavy Gauge Steel Construction (Indoor)
 - Colors: Gray (Paintable), Custom Colors -CC
 - 10.00in H x 12.25in W x 4.00in D (25.40cm x 31.12cm x 10.16cm) 7.00lbs (3.20kg)
- C **Square Grille** **V-936480**
 - Designed for Mounting 8-Inch Speaker Assembly
 - Colors: White (Paintable), Custom Colors -CC
 - 11.50in L x 11.50in L x 0.20in D (29.21cm x 29.21cm x 0.51cm) 1.00lbs (0.45kg)

Choose Backbox for V-936480

- Angled Mount** **VB-A13** 

11.54in H x 11.63in W x 4.60in D1 x 3.15in D2 (29.31cm x 29.54cm x 11.68cmD1 x 8.00cmD2)
- Recessed Mount** **VB-R12** 

10.75in H x 10.75in W x 3.94in D (27.31cm x 27.31cm x 10.01cm)
- Surface Mount** **VB-S11** 

11.63in H x 11.63in W x 3.94in D (29.54cm x 29.54cm x 10.01cm)

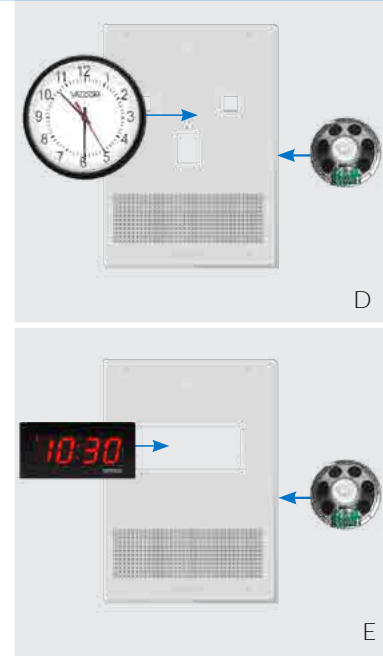

Clock/Speaker Assemblies

See pages 32-33 for Clocks

Choose Faceplate

Color: White, Light Texture Powder Paint

- D **Analog Baffle for 12-Inch Clock & 8-Inch Speaker** **V-CSB12S**

20.32in H x 14.41in W x 0.56in D (51.44cm x 36.53cm x 1.42cm) 2.40lbs (1.09kg)
- E **Digital Baffle for 4 Digit, 2.5-Inch Clock & 8-Inch Speaker**. **V-CSB25**

20.25in H x 14.38in W x 0.56in D (51.44cm x 36.53cm x 1.42cm) 2.40lbs (1.09kg)

Choose Backbox

- Angled Mount** **VB-A21** 

19.88in H x 14.27in W x 6.27in D1 x 2.72in D2
(50.50cm x 36.25cm x 15.93cmD1 x 6.91cmD2)
- Recessed Mount** **VB-R19** 

19.25in H x 10.75in W x 3.75in D (48.90cm x 27.31cm x 9.23cm)
- Surface Mount** **VB-S20** 

20.18in H x 14.27in W x 2.78in D (51.26cm x 36.25 x 7.06cm)



Choose 8-Inch Speaker Assemblies

- F **24 V Speaker (w/Amplifier)** **VSA-1020C -1**

8.00in Dia x 2.25in D (20.32cm x 5.72cm) 2.50lbs (1.13kg)
- G **45 Ohm Talkback (4 Volume)**. **V-936418 0**

8.00in Dia x 2.75in D (20.32cm x 6.99cm) 1.30lbs (0.59kg)
- H **25/70 V** **V-936400 0**

8.0in Dia x 2.25in D (20.32cm x 5.72cm) 1.70lbs (0.77kg)

Partner with us

Competitive advantage

Provide a complete solution

Value added revenues

Increase profits with desirable upgrades

Lead the way with innovative solutions

Get compensated for your efforts

Better complete/converged solutions

Convergence saves money

Technology you know

IP solutions are already your expertise

INNOVATION

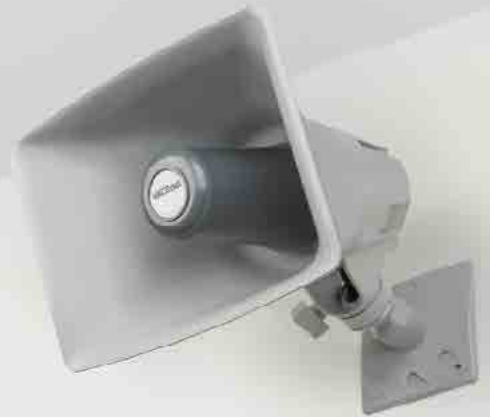

5614 Hollins Road
Roanoke, VA 24019

1.540.563.2000
global@valcom.com
www.valcom.com

VALCOM[®]
INTERNATIONAL

2022 V1.1

www.valcom.com/resources/international

948935